

Circuit Protective Components for Consumer Electronics



Innovation to power your vision

Innovative Circuit Protection Solutions

Highly Reliable Products for Applications from Aerospace to Consumer Electronics

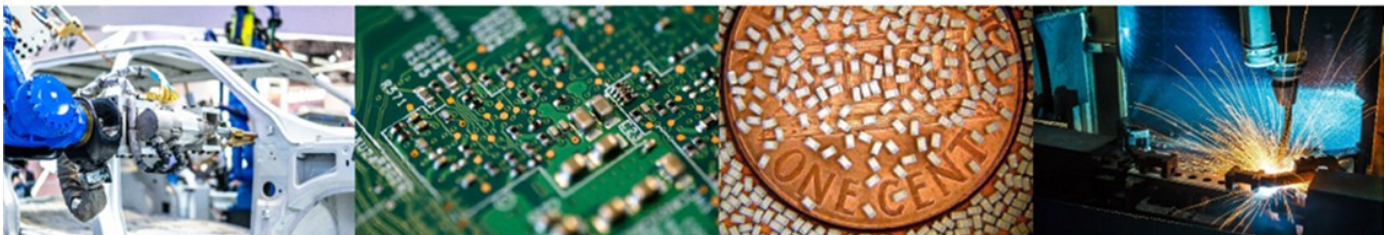

Company Overview

AEM, a global manufacturer of electronic components, was founded to redefine the standards of quality and value in the industry with continuous innovation.



ISO 9001:2015



IATF 16949:2016



ISO 14001:2015

AEM, headquartered in San Diego, California, is a global leader in providing innovative circuit protection solutions.

AEM designs and produces mission-critical, passive circuit protection components through two divisions. AEM's A&D division provides advanced, high-reliability fuses, ferrite chip beads, and tin whisker mitigation products for satellite, defense, and aerospace applications. Its products, which are often custom and application-specific in nature, are used in harsh, technical environments where performance is mission critical. AEM has a deep heritage in high-reliability components and a reputation as a market leading supplier of such components.

AEM's Commercial division provides high-end SolidMatrix® and AirMatrix® surface mount fuses and inductive components for commercial applications, including IT, visual display, automotive and EV, power tools, lithium battery, 5G, IoT, security devices, and telecom. The division focuses on providing complex, highly-engineered components for use in safety critical applications which demand superior performance specifications and smaller form factors.

AEM Technology Platforms

INNOVATIVE CIRCUIT PROTECTION



AEM Product Portfolios

- **Commercial Circuit Protective Components**
 - SolidMatrix® Multilayer Monolithic Chip Fuses
 - AirMatrix® Surface Mount Fuses
 - TF-FUSE® Surface Mount Fuses
 - CMF High Power Surface Mount Fuses
 - Automotive Surface Mount Fuses

Company Overview

AEM, a global manufacturer of electronic components, was founded to redefine the standards of quality and value in the industry with continuous innovation.



ISO 9001:2015



IATF 16949:2016



ISO 14001:2015

AEM Quality Assurance

AEM Suzhou facility is IATF 16949:2016, ISO 9001:2015 and ISO 14001:2016 certified. Long known for its high quality products and exceptional customer service, AEM also provides a 7x24 technical support hotline.

AEM is committed to constantly striving for excellence and perfection in providing products and customer services with the highest quality and value.

SolidMatrix[®] Chip Fuses

AEM offers the broadest line of surface mount chip fuses in the industry. AEM SolidMatrix[®] Surface Mount Chip Fuses are recognized by Underwriters Laboratories (UL). Constructed as a multilayer monolithic structure using a co-firing process, these fuses offer superior mechanical integrity and are ideal for applications in LCD monitors, PC cards, disk drives, portable communication products, PDAs, digital cameras, DVDs, TVs, cell phones, rechargeable battery packs, battery chargers, etc.

AirMatrix[®] Surface Mount Fuses

With multiple internal safety approvals, high consistency and excellent inrush current withstanding capability, AEM's AirMatrix[®] wire-in-air surface mount fuses are ideal for applications with high voltage and high inrush current, such as converters, inverters, lightings, LED drivers, LCD monitors, notebooks, PC servers, communication technology devices, office automation electronics, industrial equipment, home electrical applications, etc.

CMF High Power Surface Mount Fuses

AEM Components introduces a new line high-current, high-power density surface mount solid body fuses. The new CMF Series is available in both commercial and automotive grade (AEC-Q200 qualified) versions, with part numbers at current ratings from 20A to 125A. All models in this series are offered in the same 2822 case size package. This standardized footprint for all models is a great benefit in platform design.

CONTENTS

Overview of SolidMatrix[®] Surface Mount Fuses	1
Overview of AirMatrix[®] Surface Mount Fuses	2
Overview of TF-FUSE[®] Surface Mount Fuses	3
Overview of CMF Surface Mount Fuses	4
Surface Mount Fuses Quick Index	5
SolidMatrix[®] Surface Mount Fuses	6
Recommended Land Pattern	6
Environmental Tests	6
Electrical Specification	7
Fuse Selection and Temperature De-rating Guideline	7
Soldering Temperature Profile	8
Packaging	8
FA Series	9
1206 Size	9
0603 Size	12
0402 Size	15
SB Series	18
1206 Size	18
0603 Size	21
HI Series	24
1206 Size	24
0603 Size	27
HA Series	30
1206 Size	30
HB Series	33
1206 Size	33

HC Series	36
1206 Size	36
FF Series	39
0603 Size	39
VH Series	42
1206 size	42
TF-FUSE[®] Thin Film Surface Mount Fuses	45
Product Identification	45
Environmental Tests	45
Packaging	45
Temperature Effect on Current Rating	46
Recommended Reflow Soldering Profile	46
FF Series 0402 Size	47
FF Series 0603 Size	50
HI Series 0603 Size	53
AirMatrix[®] Surface Mount Fuses	56
Product Identification	56
Fuse Selection and Temperature De-rating Guideline	57
Soldering Temperature Profile	58
AF Series	59
1206 Size	59
2410 Size (AF2)	63
AF101 Series	67
MF Series	72
2410 Size	72
CMF High Power Surface Mount Fuse	76
CM2822H Series	76

SolidMatrix[®] Surface Mount Chip Fuses

Solid Construction with Superior Performance

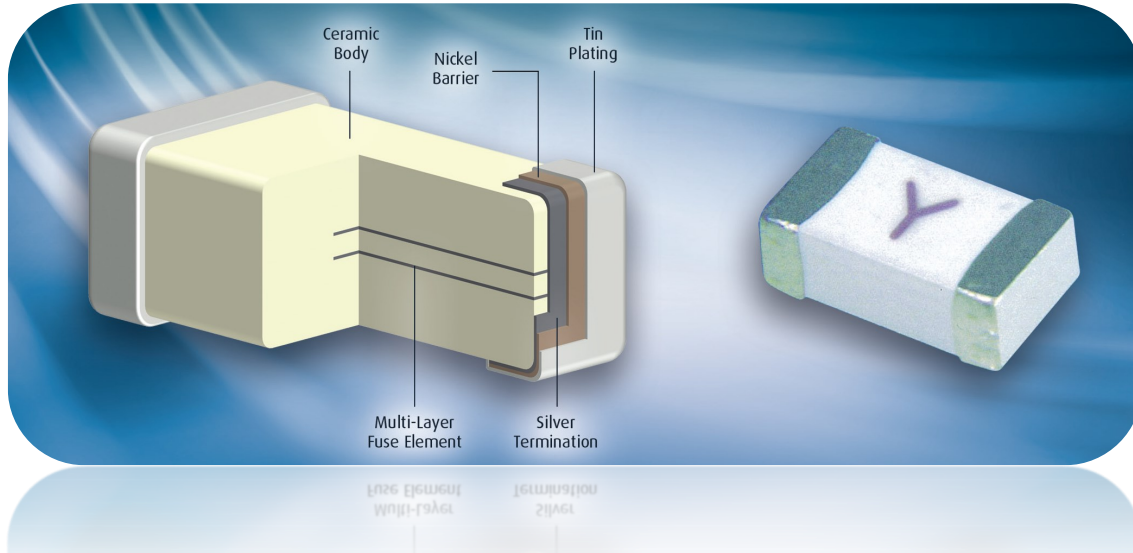

Fuse links and arc suppressing material are buried inside of fuse body. When fuse link opens, there is no fly arc or spark leak. Multiple fuse links design in parallel could improve the amperage rating and save board space. Fuse element diffused into ceramic body, so the integrity of fuse body is maintained and the airtight package is preserved.

SolidMatrix[®] Features:

- Solid body with multilayer fuse link structure
- Maintains mechanical integrity and safely clears with no debris and no collateral damage
- No prolonged arcing even at higher voltage conditions
- Wide range of current and voltage ratings in EIA 0402, 0603 and 1206 case sizes
- Circuit protection catachrestic from very fast acting, fast acting, slow blow to high in-rush
- Reliable design with consistent performance characteristics

SolidMatrix[®] Applications:

- Power-over-Ethernet
- Panel & Display
- PC & Notebook
- Power tools
- Server and storage systems
- Battery, BMS and infotainment systems

AirMatrix® Surface Mount Chip Fuses

Advanced Wire-In-Air Construction with International Safety Approvals

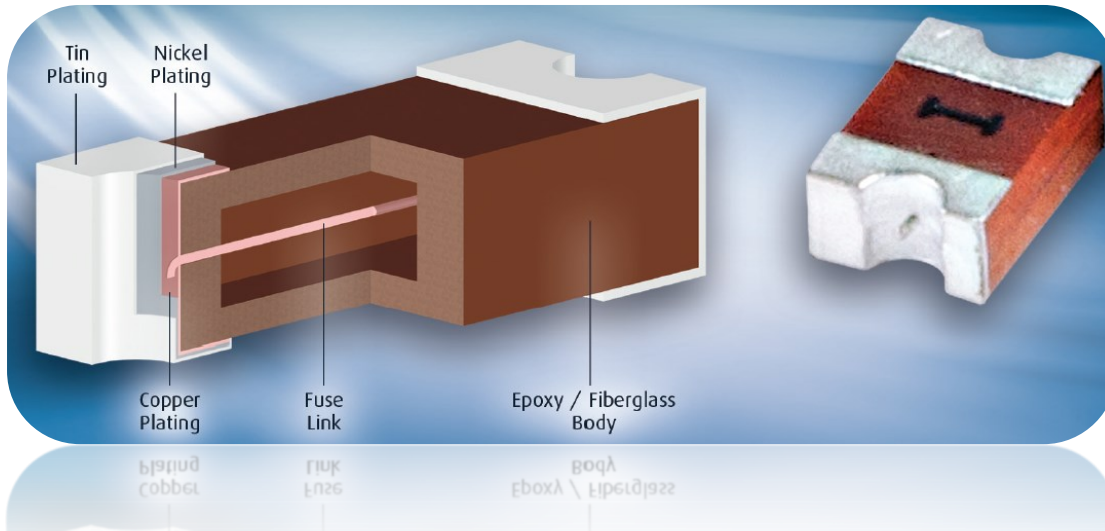

One of the industry's smallest 250V surface mount fuses, the AirMatrix product series are primarily designed for overcurrent protection of line voltage circuits and are widely used in power, battery and server applications. The innovations of AEM's unique material, product design and manufacturing processes provide better reliability, stability and performance.

AirMatrix® Features:

- Airtight robust package prevents outgassing and moisture issues
- Solderless SMD construction
- High in-rush current withstanding capability
- Best in class volumetric efficiency
- Consistent and predictable performance characteristics even in extreme conditions
- Over current protection of line voltage circuits for power applications

AirMatrix® Applications:

- Automotive, EV and Battery
- Power Supplies
- Medical & Industrial Equipment
- White Goods
- Consumer Electronics
- LED Lighting

TF-FUSE[®] Surface Mount Chip Fuses

Low Profile TF-FUSE[®] with Superior Performance

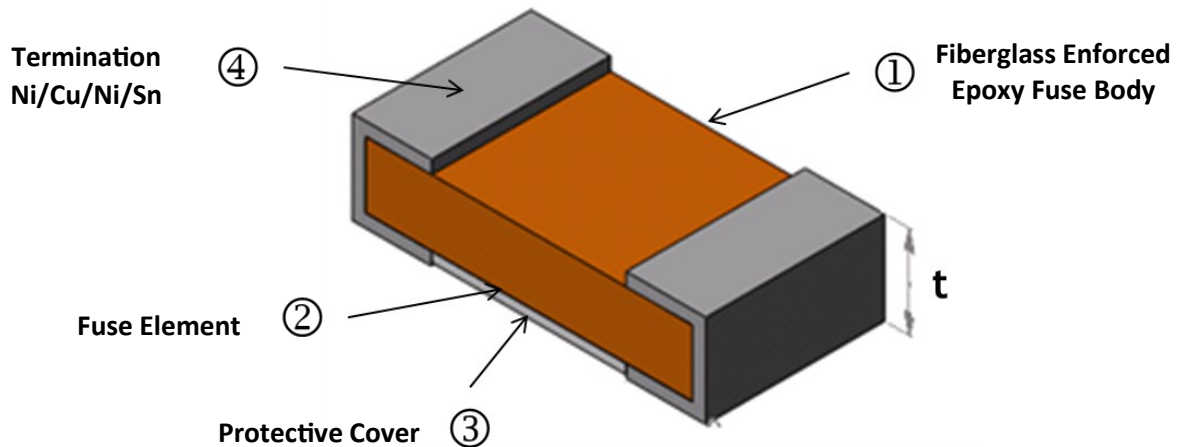

With patent technology and by integrating the advanced thin film technology, AEM thin film fuses offer a fusing characteristic from very fast acting to high in-rush current. The fiberglass enforced epoxy fuse body and bi-metal fuse element make fuse to provide protection at low fusing temperature.

TF-FUSE[®] Features:

- Low rating current capability (from 150mA to 5A)
- Low DCR
- Low fusing ratio
- Low fusing temperature
- Low profile (thickness ~ 0.3mm)
- Small case size (EIA 0402 & 0603)

TF-FUSE[®] Applications:

- Notebook computers and tablets
- Memory cards, HDD
- Toys
- Portable electronic devices
- Panels
- Battery pack

CMF High Power Surface Mount Fuses

Robust Construction at Best-in-Class Safe Power Density

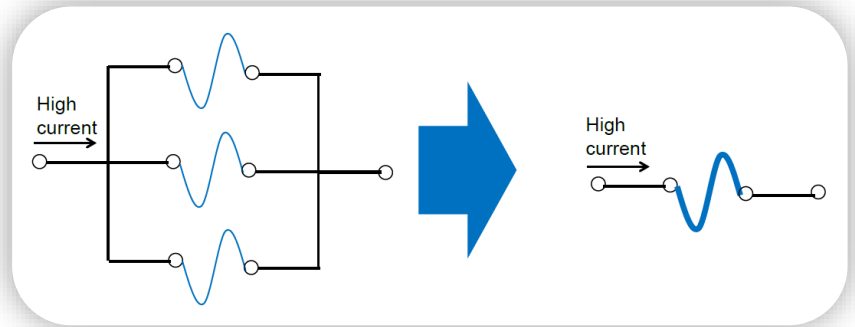

The CMF high power surface mount fuses build on AEM advanced manufacturing technology. The solid, robust structure assures reliable operation in environments where temperature cycling and high mechanical vibration are present. The devices singular fuse link/terminal construction eliminates problems that occur with traditional ceramic tube interconnection techniques

CMF High Power Fuse Features:

- Thermal simulation on critical fuse element design with optimized & safe fuse performances
- Standardized 2822 footprint / miniaturized package for current rating from 20A to 125A
- 100% interconnection reliability with single piece of metal functioning as fuse link and surface mount terminations
- Low DC resistance (DCR) – Minimizes excessive power loss
- Automotive grade with AEC-Q200 Rev.E qualification
- High interrupting ratings – for excellent inrush current capability

CMF High Power Fuse Applications:

- Drones
- Power tools
- Energy storage
- Power distribution units
- Data, server and cloud systems
- UPS/Routers
- EV, BMS and battery
- E-Bike

Surface Mount Fuses

Quick Index:

Series	Size	Current Rating (A)	Voltage Rating	Page	
SolidMatrix®	FA (Fast Acting)	1206	0.5, 0.75, 1.0, 1.5, 1.75, 2.0	63VDC	9
			2.5, 3.0, 4.0, 5.0, 6.0, 7.0, 8.0	32VDC	
		0603	0.5, 0.75, 1.0, 1.5	63VDC	12
			2.0, 2.5, 3.0, 3.5, 4.0, 5.0	32VDC	
			6.0	24VDC	
		0402	0.5, 0.75, 1.0, 1.5, 2.0, 3.0, 4.0, 5.0, 6.0, 7.0, 8.0	24VDC	15
	SB (Slow Blow)	1206	1.0, 1.25, 1.5, 2.0	63VDC	18
			2.5, 3.0, 3.5, 4.0, 4.5, 5.0	32VDC	
			5.5, 6.0, 7.0, 8.0	24VDC	
	0603	1.0, 1.5, 2.0, 2.5, 3.0, 3.5, 4.0, 4.5, 5.0, 6.0, 7.0, 8.0	32VDC	21	
		HI (High Inrush)	1206	0.5, 0.75	65VDC
	1.0, 1.5, 2.0			63VDC	
	2.5, 3.0, 3.5, 4.0, 4.5, 5.0			32VDC	
	6.0, 7.0, 8.0			24VDC	
	0603	1.0, 1.5, 2.0, 2.5, 3.0, 3.5, 4.0, 4.5, 5.0, 6.0, 7.0, 8.0	32VDC	27	
	HA (High Current)	1206	10, 12, 15, 20	24VDC	30
HB (High Current)	1206	10, 12, 15, 20, 25, 30	24VDC	33	
HC (High Current)	1206	10, 12, 15, 20, 25, 30, 40	35VDC	36	
FF (Very Fast Acting)	0603	0.5, 0.75, 1.0, 1.25, 1.5, 1.75, 2.0, 2.5, 3.0, 3.5, 4.0, 4.5, 5.0	32VDC	39	
VH (Voltage High)	1206	2.5, 3.0, 3.5, 4.0, 4.5, 5.0	65VDC	42	
		6.0, 7.0, 8.0	48VDC		
TF-FUSE®	FF (Very Fast Acting)	0402	0.20, 0.25, 0.375, 0.50, 0.75, 1.00, 1.25, 1.50, 1.75, 2.00, 2.5, 3.00, 3.50, 4.00, 5.00	35VDC	47
			0603	0.150, 0.200, 0.250, 0.375, 0.50, 0.75, 1.00, 1.25, 1.50	65VDC
	1.75, 2.00, 2.50, 3.00, 3.50, 4.00, 5.00	35VDC			
	HI (High Inrush)	0603	0.50, 0.75, 1.00, 1.50	65VDC	53
2.00, 2.50, 3.00, 3.50, 4.00			35VDC		
AirMatrix®	AF	1206	1.50, 1.60, 2.00, 2.50, 3.00, 3.15, 3.50, 4.00	65VDC	59
			5.00, 6.30, 7.00, 8.00, 10.0, 12.0, 15.0	32VDC	
		2410	0.5, 0.63, 0.75, 1.0, 1.25, 1.5, 2.0	250VAC/125VDC	63
			2.5, 3.0, 3.15, 3.5, 4.0, 5.0, 6.3, 7.0, 8.0, 10.0	125VAC/DC	
			12.0, 15.0, 20.0	65VAC/DC	
	101 Series		20,25,30,40,50,60	75VDC	67
MF	2410	0.50, 0.63, 0.80, 1.00, 1.25, 1.60, 2.00	250VAC	72	
High Power	CMF	2822	20, 30, 40, 50	125VDC	76
			60, 70, 80, 90, 100, 125	75VDC	

SolidMatrix® Surface Mount Fuses

Product Identification:

F 0603 FA 1000 V032 T M

(1) (2) (3) (4) (5) (6) (7)

- (1) **Product Code:** F— Chip Fuse
- (2) **Size Code:** Standard EIA Chip Sizes
- (3) **Series Code:** FA - Fast Acting, SB - Slow Blow,
HI - High Inrush, FF - Very Fast Acting, HB - High Current
- (4) **Current Rating Code:** 1000 - 1000 mA (For HB, 10 - 10A)
- (5) **Voltage Rating Code:** V032 - 32 VDC
- (6) **Package Code:** T - Tape & Reel, B - Bulk
- (7) **Marking Code:** M - With Marking

F 1206 HC 20A0 T M

(1) (2) (3) (4) (5) (6)

- (1) **Product Code:** F— Chip Fuse
- (2) **Size Code:** L x W (inch),
the first two digits-L (length),
the last two digits-W (width)
- (3) **Series Code:** HC Series
- (4) **Current Rating Code:** 20A0—20.0A
- (5) **Package Code:** T - Tape & Reel, B - Bulk
- (6) **Marking Code:** M - With Marking

Recommended Land Pattern:

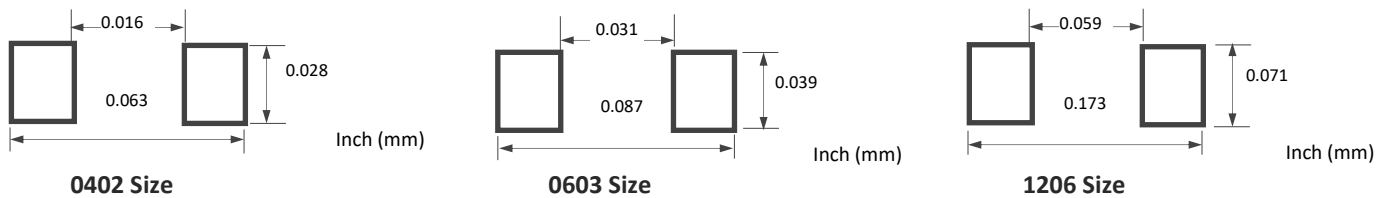

Environmental Tests:

No.	Test	Test Condition and Requirement	Test reference
1	Soldering heat resistance	DCR change $\leq \pm 10\%$. No mechanical damage One dip at 260°C for 60 seconds	MIL-STD-202 Method 210
2	Solderability	245°C, 5 seconds, new solder coverage $\geq 95\%$	MIL-STD-202 Method 208
3	Thermal shock	DCR change $\leq \pm 10\%$. No mechanical damage 100 cycles between -65°C and +125°C	MIL-STD-202 Method 107
4	Moisture resistance	10 cycles, DCR change $\leq \pm 10\%$, no excessive corrosion	MIL-STD-202 Method 106
5	Salt spray	DCR change $\leq \pm 10\%$. No excessive corrosion 48 hour exposure	MIL-STD-202 Method 101
6	Mechanical vibration	DCR change $\leq \pm 10\%$. No mechanical damage. 0.4" D.A. or 30 G between 5 – 3000 Hz	MIL-STD-202 Method 204
7	Mechanical shock	DCR change $\leq \pm 10\%$. No mechanical damage. 1500 G, 0.5 ms, half-sine shocks	MIL-STD-202 Method 213
8	Life	80% rated current (75% for <1A), 2000 hours, ambient temperature (from +20°C to 30°C), voltage drop change within $\pm 10\%$	Refer to AEM QIQ106

Moisture Sensitivity Level 1

SolidMatrix[®] Surface Mount Fuses

Electrical Specification:

Clearing Time Characteristics:

Same as specified on the Short Form Data Sheet

Insulation Resistance after Opening:

20,000 ohms typical when cleared with rated voltage applied. Fuse clearing under low voltage conditions may result in lower after clearing insulation resistance values. (Note: Under normal fault conditions (low or rated voltage conditions), AEM SolidMatrix fuses provide sufficient after clearing insulation resistance values for circuit protection.)

Current Carrying Capacity:

100% rated current at +25°C ambient for 4 hours minimum when evaluated per MIL-PRF-23419

Interrupt Ratings:

Same as specified in this catalog.

Fuse Selection and Temperature De-rating Guideline:

The ambient temperature affects the current carrying capacity of fuses. When a fuse is operating at a temperature higher than 25°C, the fuse shall be “de-rated”.

To select a fuse from the catalog, the following rule may be followed:

Catalog Fuse Current Rating = Nominal Operating Current / 0.75 / % De-rating at the maximum operating temperature.

Example: At maximum operating temperature of 65°C, % De-rating is 90%. The nominal operating current is 4 A. The current rating for fuse selected from the catalog shall be: $4 / 0.75 / 90\% = 5.9$ or 6 A. Specifications and descriptions in this literature are as accurate as known at the time of publish, but are subject to change without notice.

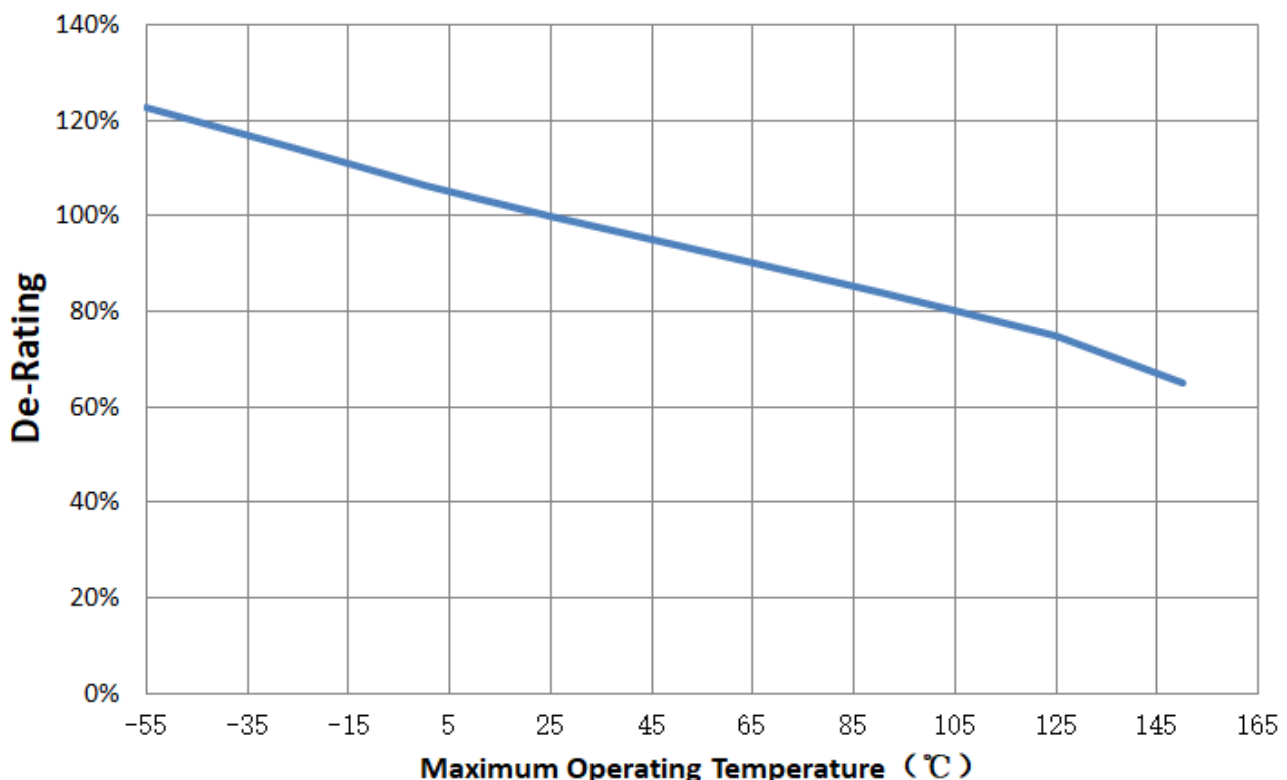

SolidMatrix[®] Surface Mount Fuses

Soldering Temperature Profile:

* Recommended Temperature Profile for Reflow Soldering

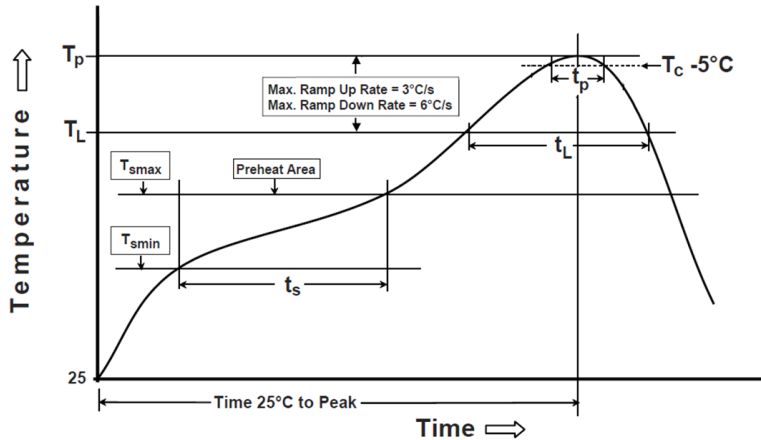

Profile Feature	Pb-Free Assembly
Preheat/Soak Temperature Min (T_{smin}) Temperature Max (T_{smax}) Time (t_s) from (T_{smin} to T_{smax})	150°C 200°C 60~120 seconds
Ramp-up rate (T_L to T_p)	3°C/second max.
Liquidous temperature (T_L) Time (t_L) maintained above T_L	217°C 60~150 seconds
Peak package body temperature (T_p)	260°C
Time (t_p)* within 5°C of the specified classification temperature (T_c)	30 seconds *
Ramp-down rate (T_p to T_L)	6°C/second max.
Time 25°C to peak temperature	8 minutes max.
* Tolerance for peak profile temperature (T_p) is defined as a supplier minimum and a user maximum	

* Recommended Temperature Profile for Wave Soldering

Recommended Temperature Profile for Wave Soldering

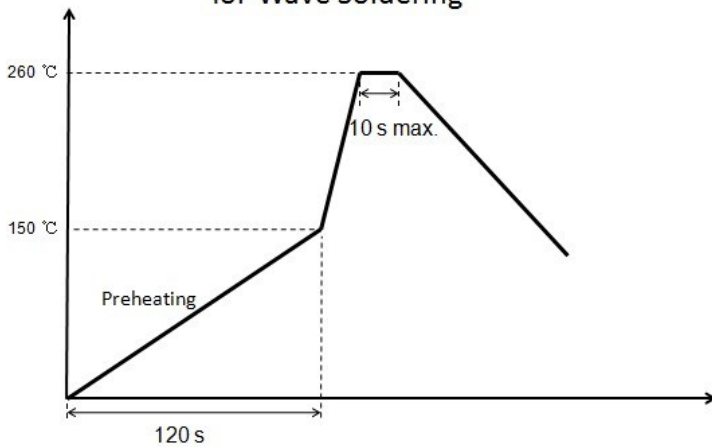

Notice: Wave Soldering is suitable for 1206 and 0603 size.

Packaging:

Chip Size	Parts on 7 inch (178 mm) Reel
0402 (1005)	10,000
0603 (1608)	4,000
0603FF (1608)	6,000
1206 (3216)	3,000

SolidMatrix® Surface Mount Fuses

FA Series (Fast Acting), 1206 Size



Features:

- Multilayer monolithic structure with glass ceramic body and silver fusing element
- Silver termination with nickel and pure-tin solder plating, providing excellent solderability
- Compatible with both wave and reflow soldering processes
- Operating temperature range: -55°C to +150°C (with de-rating)

Clearing Time Characteristics:

% of current rating	Clearing time at 25°C
100%	4 hours min.
250%	5 seconds max.
400%	0.05 seconds max.

Shape and Dimensions:

Unit	Inch	mm
L	0.126 ± 0.008	3.20 ± 0.20
W	0.063 ± 0.008	1.60 ± 0.20
T	0.043 ± 0.008	1.10 ± 0.20
B	0.020 ± 0.010	0.51 ± 0.25

Agency Approval:

Recognized Under the Components Program of UL.
File Number: E232989.

Applications:

- Panel
- Power tools
- PC & Notebook
- Server
- Battery pack
- Dock station

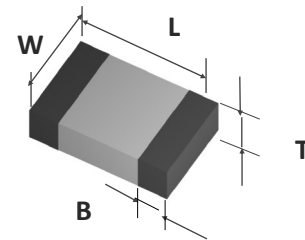

Ordering Information:

Part Number	Current Rating (A)	Voltage Rating (Vdc)	Interrupting Ratings	Nominal Cold DCR (Ω) ¹	Nominal I ² t (A ² s) ²	Marking Code ³
F1206FA0500V063TM	0.5	63	50 A at rated voltages	0.730	0.002	C
F1206FA0750V063TM	0.75	63		0.513	0.005	D
F1206FA1000V063TM	1.0	63		0.220	0.011	E
F1206FA1500V063TM	1.5	63		0.120	0.024	G
F1206FA1750V063TM	1.75	63		0.100	0.045	H
F1206FA2000V063TM	2.0	63		0.050	0.075	I
F1206FA2500V032TM	2.5	32		0.035	0.11	J
F1206FA3000V032TM	3.0	32	0.031	0.21	K	
F1206FA4000V032TM	4.0	32	45 A at rated voltages	0.022	0.35	M
F1206FA5000V032TM	5.0	32	0.015	0.60	N	
F1206FA6000V032TM	6.0	32	50 A at rated voltages	0.013	1.0	+
F1206FA7000V032TM	7.0	32		0.011	1.6	-
F1206FA8000V032TM	8.0	32		0.008	2.3	=

1. Measured at ≤ 10% rated current and 25°C ambient. 2. Melting I²t at 0.001 second pre-arcing time. 3. Black Marking Character Code.

SolidMatrix® Surface Mount Fuses
FA Series (Fast Acting), 1206 Size

Average Pre-arcing Time Curves:

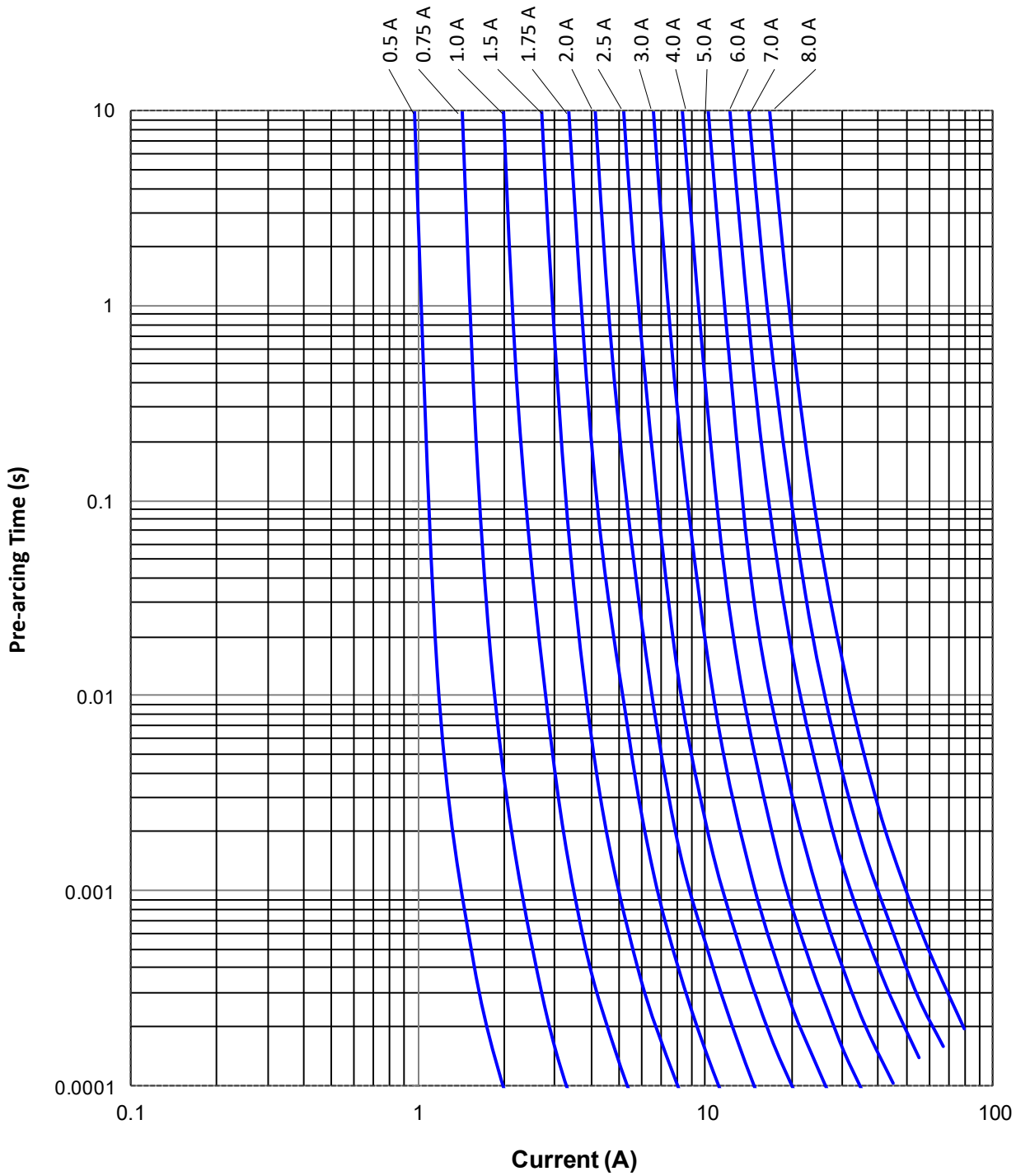

SolidMatrix® Surface Mount Fuses
FA Series (Fast Acting), 1206 Size

Average I^2t vs. t Curves:

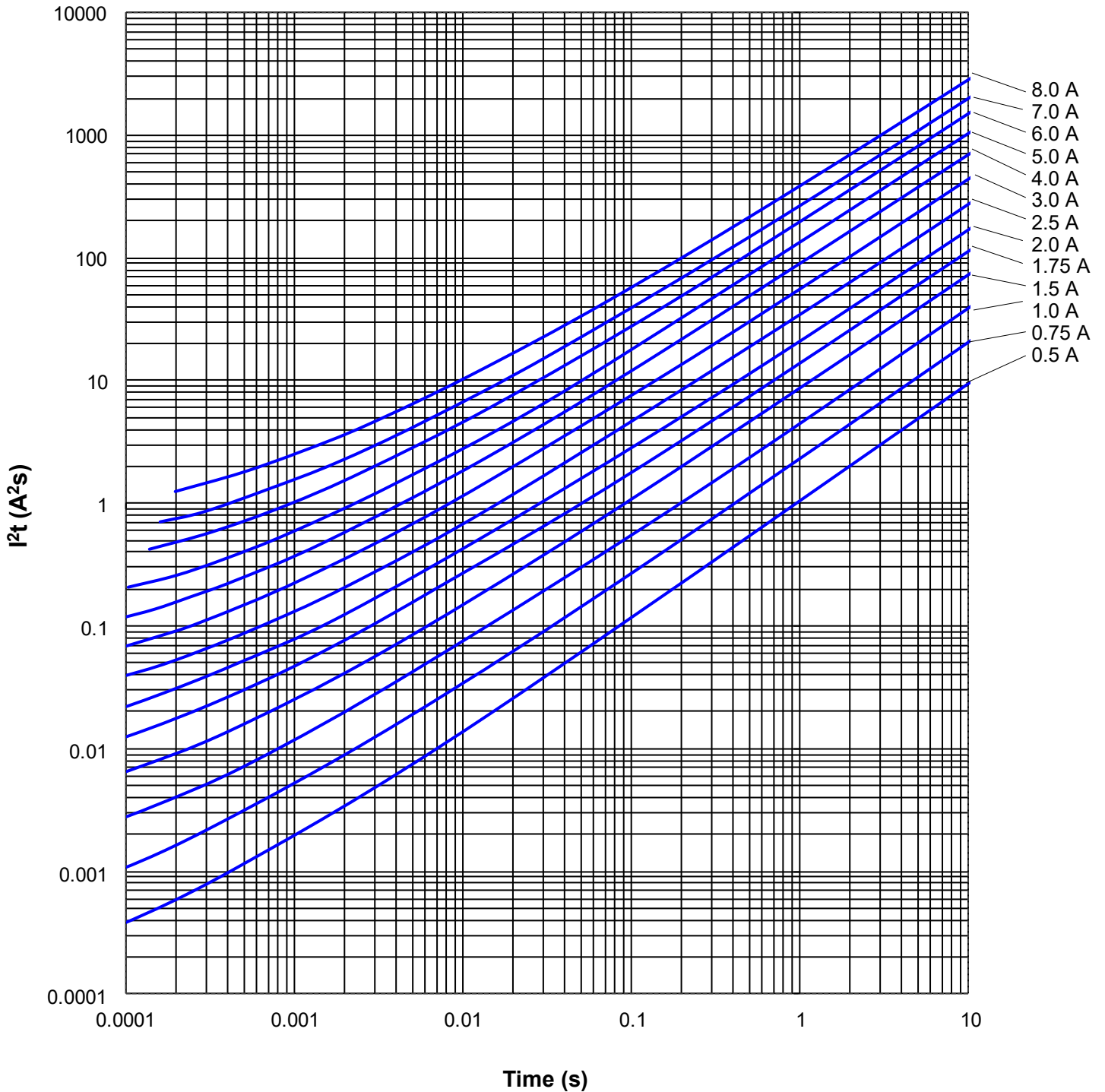

SolidMatrix[®] Surface Mount Fuses

FA Series (Fast Acting), 0603 Size



Features:

- Multilayer monolithic structure with glass ceramic body and silver fusing element
- Silver termination with nickel and pure-tin solder plating, providing excellent solderability
- Compatible with both wave and reflow soldering processes
- Operating temperature range: -55°C to +150°C (with de-rating)

Clearing Time Characteristics:

% of current rating	Clearing time at 25°C
100%	4 hours min.
250%	5 seconds max.
400%	0.05 seconds max.

Shape and Dimensions:

Unit	Inch	mm
L	0.063 ± 0.006	1.60 ± 0.15
W	0.031 ± 0.006	0.80 ± 0.15
T	0.031 ± 0.006	0.80 ± 0.15
B	0.014 ± 0.006	0.36 ± 0.15

Agency Approval:

Recognized Under the Components Program of UL.
 File Number: E232989.

Applications:

- Panel
- Notebook
- Toy
- Battery pack
- IoT
- Infotainment System

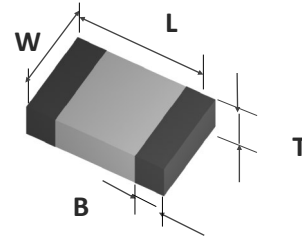

Ordering Information:

Part Number	Current Rating (A)	Voltage Rating (Vdc)	Interrupting Ratings	Nominal Cold DCR (Ω) ¹	Nominal I ² t (A ² s) ²	Marking (Optional) ³
F0603FA0500V063TM	0.5	63	35 A at rated voltages	0.485	0.003	C
F0603FA0750V063TM	0.75	63		0.254	0.006	D
F0603FA1000V063TM	1.0	63		0.147	0.013	E
F0603FA1500V063TM	1.5	63		0.059	0.030	G
F0603FA2000V032TM	2.0	32		0.044	0.060	I
F0603FA2500V032TM	2.5	32		0.032	0.10	J
F0603FA3000V032TM	3.0	32		0.025	0.18	K
F0603FA3500V032TM	3.5	32		0.024	0.30	L
F0603FA4000V032TM	4.0	32		0.018	0.50	M
F0603FA5000V032TM	5.0	32		0.013	0.80	N
F0603FA6000V024TM	6.0	24		0.010	1.10	O

1. Measured at ≤ 10% rated current and 25°C ambient. 2. Melting I²t at 0.001 second pre-arcing time. 3. Black Marking Character Code.

SolidMatrix[®] Surface Mount Fuses
FA Series (Fast Acting), 0603 Size

Average Pre-arcing Time Curves:

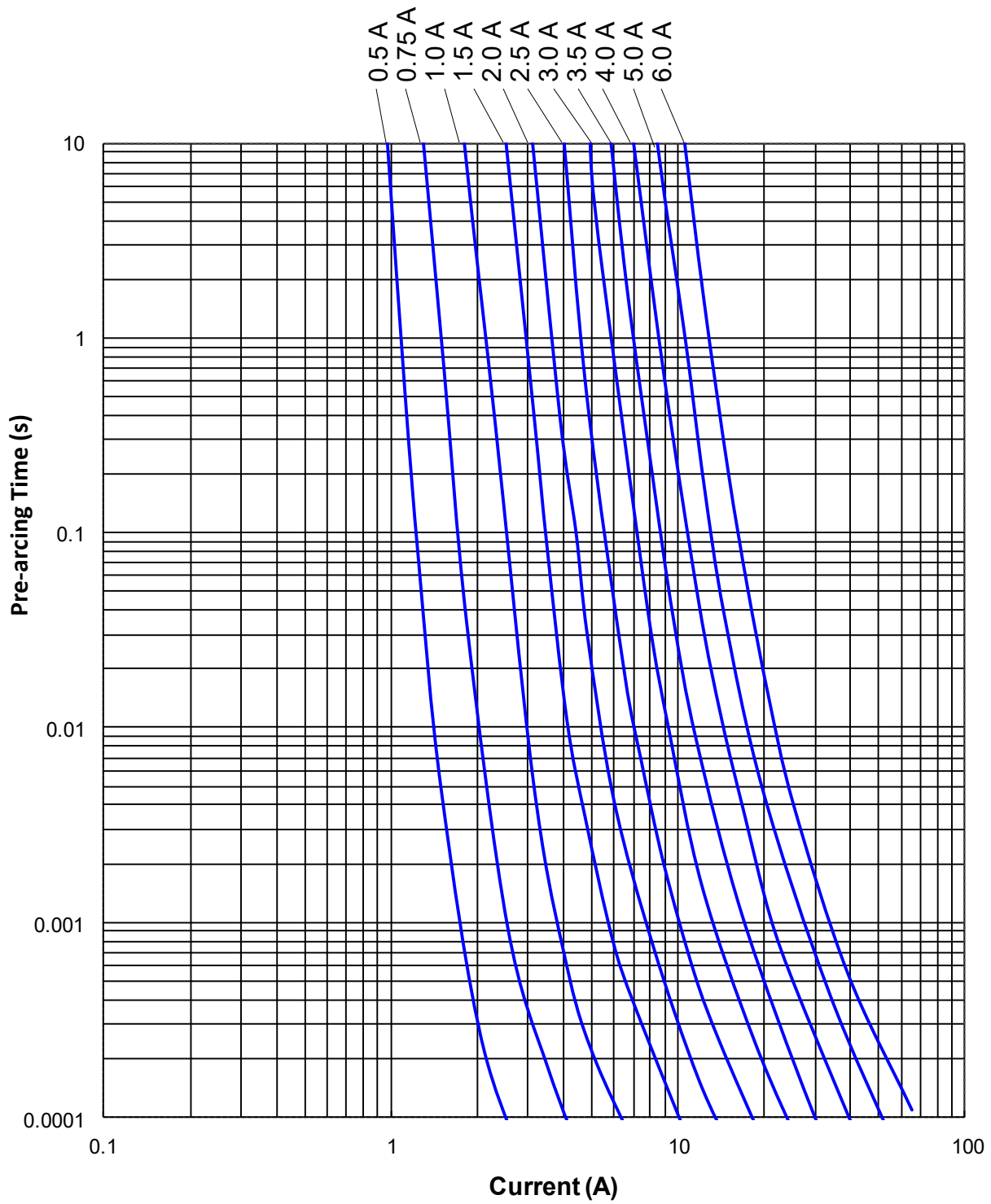

SolidMatrix[®] Surface Mount Fuses
FA Series (Fast Acting), 0603 Size

Average I²t vs. t Curves:

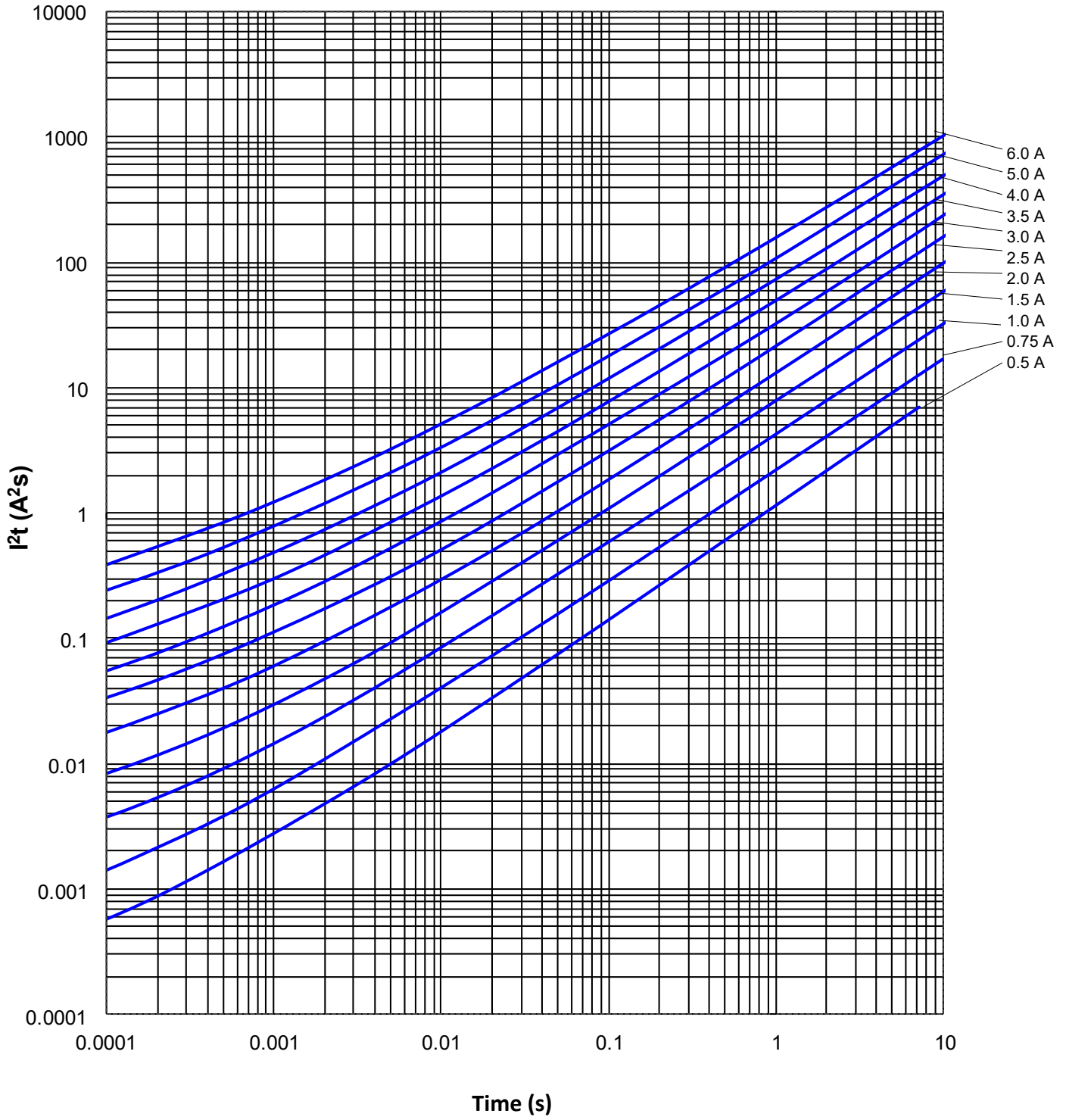

SolidMatrix® Surface Mount Fuses

FA Series (Fast Acting), 0402 Size



Features:

- Multilayer monolithic structure with glass ceramic body and silver fusing element.
- Silver termination with nickel and pure-tin solder plating, providing excellent solderability.
- Compatible with both wave and reflow soldering processes.
- Operating temperature range: -55°C to +150°C (with de-rating).
- Wide current rating from 0.5A up to 8A.
- High power density at 0402 chip size which is ideal for the miniaturization and space saving.

Clearing Time Characteristics:

% of current rating	Clearing time at 25°C
100%	4 hours min.
250%	5 seconds max.
400%	0.05 seconds max.

Shape and Dimensions:

Unit	Inch	mm
L	0.039 ± 0.004	1.00 ± 0.10
W	0.020 ± 0.004	0.51 ± 0.10
T	0.020 ± 0.004	0.51 ± 0.10
B	0.010 ± 0.004	0.25 ± 0.10

Applications:

- Panel
- Notebook
- Toy
- HDD
- IoT
- Finger print
- Smart lock
- Battery pack

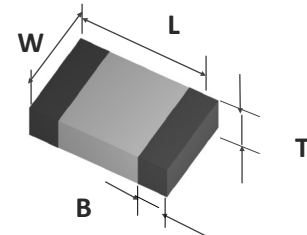

Ordering Information:

Part Number	Current Rating (A)	Voltage Rating (Vdc)	Interrupting Ratings	Nominal Cold DCR (Ω) ¹	Nominal I ² t (A ² s) ²	Agency Approval
F0402FA0500V024T	0.5	24	35 A at rated voltage	0.380	0.004	UL No.E232989
F0402FA0750V024T	0.75	24		0.210	0.007	UL No.E232989
F0402FA1000V024T	1.0	24		0.120	0.014	UL No.E232989
F0402FA1500V024T	1.5	24		0.056	0.050	UL No.E232989
F0402FA2000V024T	2.0	24		0.035	0.070	UL No.E232989
F0402FA3000V024T	3.0	24		0.021	0.11	UL No.E232989
F0402FA4000V024T	4.0	24		0.014	0.21	UL No.E232989
F0402FA5000V024T	5.0	24		0.011	0.45	Pending
F0402FA6000V024T	6.0	24		0.010	0.55	Pending
F0402FA7000V024T	7.0	24		0.008	0.80	Pending
F0402FA8000V024T	8.0	24		0.007	1.00	Pending

1. Measured at ≤ 10% rated current and 25°C ambient.

2. Melting I²t at 0.001 second pre-arcing time.

SolidMatrix[®] Surface Mount Fuses
FA Series (Fast Acting), 0402 Size

Average Pre-arcing Time Curves:

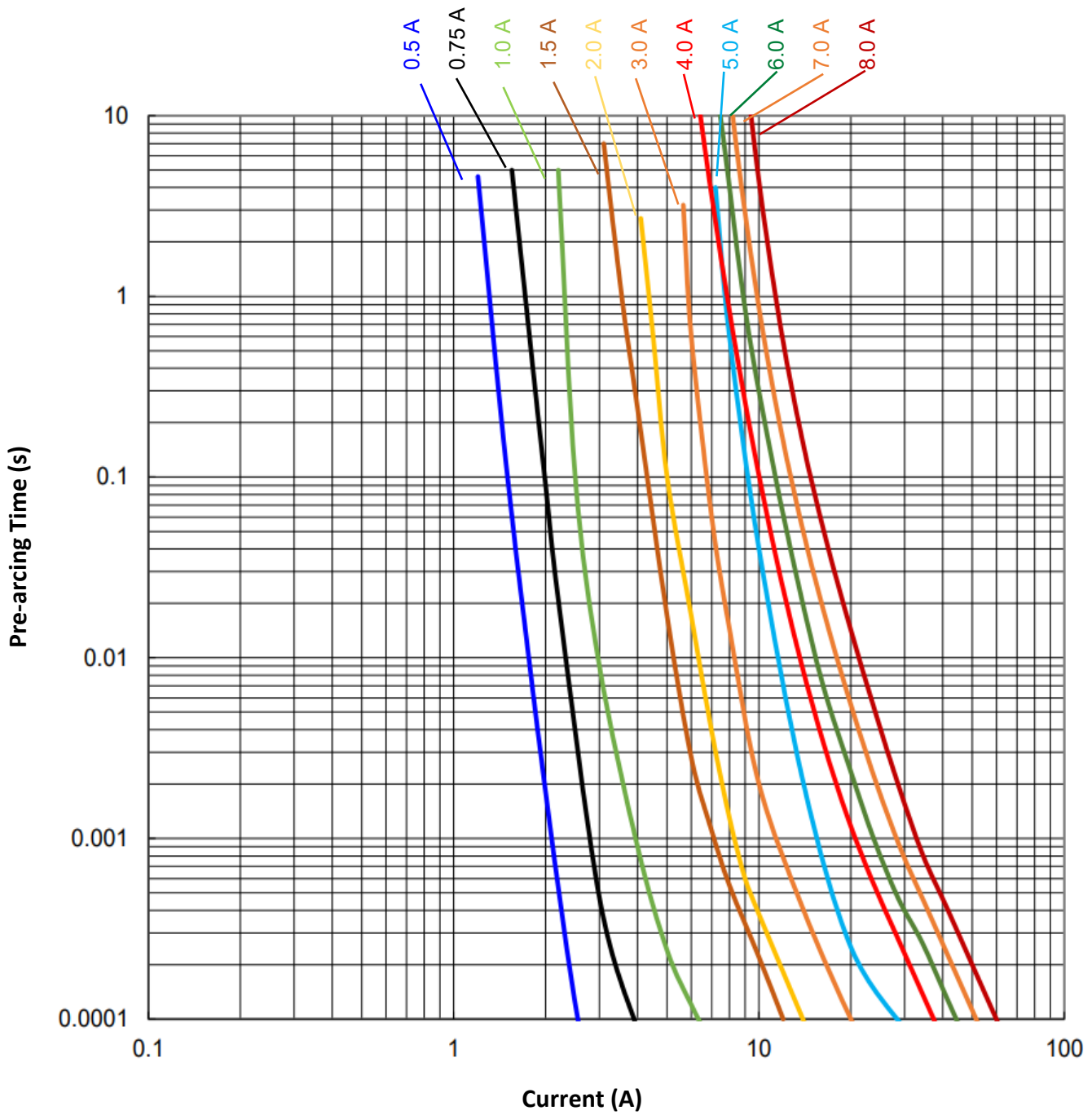

SolidMatrix® Surface Mount Fuses
FA Series (Fast Acting), 0402 Size

Average I²t vs. t Curves:

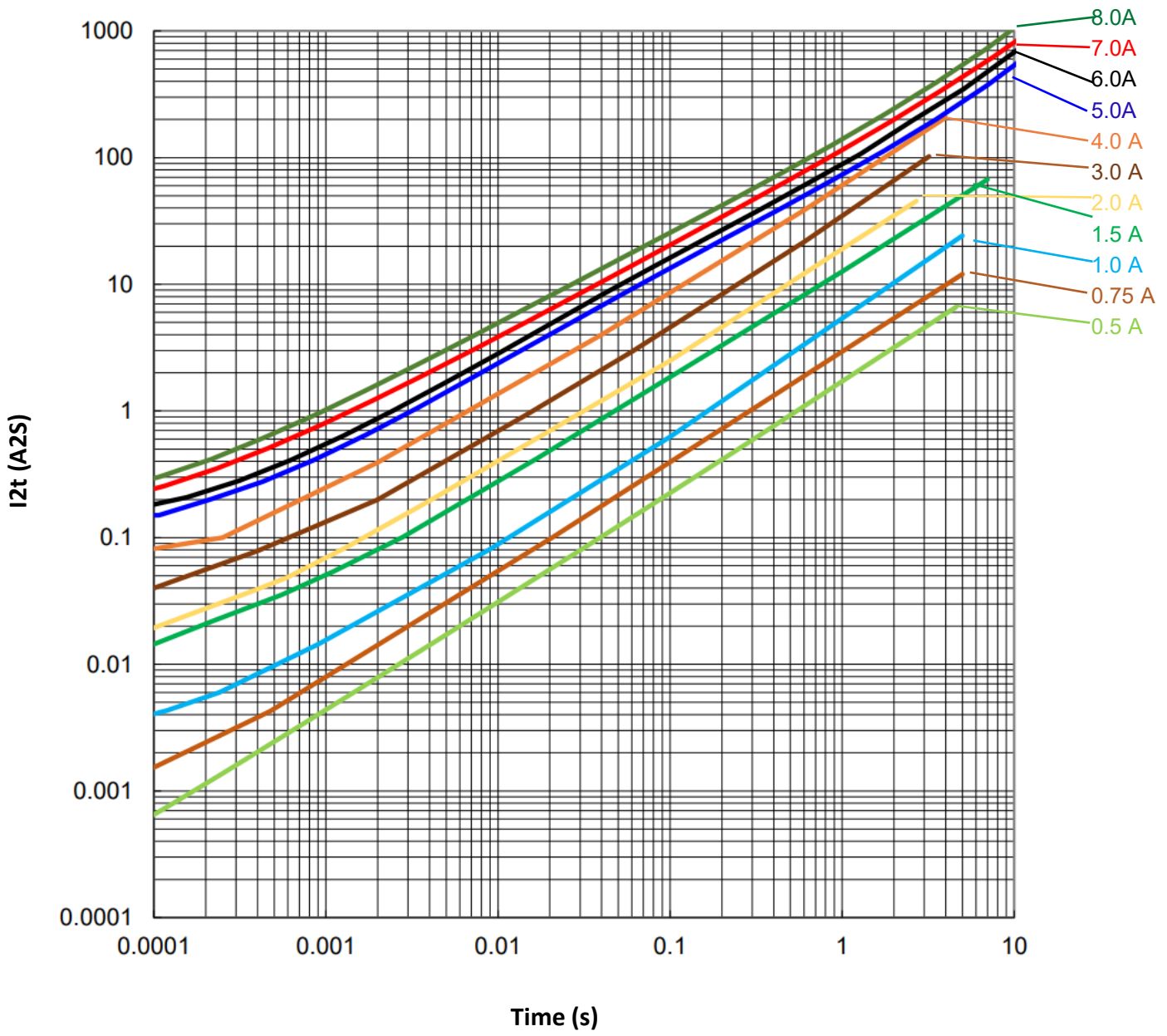

SolidMatrix® Surface Mount Fuses

SB Series (Slow Blow), 1206 Size



Features:

- High inrush current withstanding capability
- Multilayer monolithic structure with glass ceramic body and silver fusing element
- Silver termination with nickel and pure-tin solder plating, providing excellent solderability
- Compatible with both wave and reflow soldering processes
- Operating temperature range: -55°C to +150°C (with de-rating)

Clearing Time Characteristics:

% of current rating	Clearing time at 25°C	
100%	4 hours min.	
200%	1 second min.	120 seconds max.
300%	0.1 seconds min.	3 seconds max.
800%	0.002 seconds min.	0.05 seconds max.

Shape and Dimensions:

Unit	Inch	mm
L	0.126 ± 0.008	3.20 ± 0.20
W	0.063 ± 0.008	1.60 ± 0.20
T	0.038 ± 0.008	0.97 ± 0.20
B	0.020 ± 0.010	0.51 ± 0.25

Agency Approval:

Recognized Under the Components Program of UL.
 File Number: E232989.

Applications:

- Power tools
- DC-DC convert
- Display
- PC & NB
- Server
- Battery pack
- Set top box

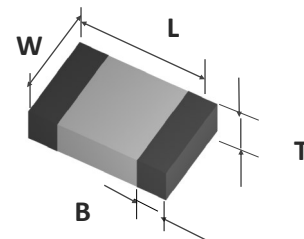

Ordering Information:

Part Number	Current Rating (A)	Voltage Rating (Vdc)	Interrupting Ratings	Nominal Cold DCR (Ω) ¹	Nominal I ² t (A ² s) ²	Marking Code ³
F1206SB1000V063TM	1.0	63	50 A at rated voltages	0.360	0.11	E
F1206SB1250V063TM	1.25	63		0.200	0.22	F
F1206SB1500V063TM	1.5	63		0.150	0.23	G
F1206SB2000V063TM	2.0	63		0.088	0.63	I
F1206SB2500V032TM	2.5	32		0.065	0.90	J
F1206SB3000V032TM	3.0	32		0.034	1.20	K
F1206SB3500V032TM	3.5	32		0.028	1.60	L
F1206SB4000V032TM	4.0	32		0.024	2.20	M
F1206SB4500V032TM	4.5	32		0.020	3.60	T
F1206SB5000V032TM	5.0	32		0.018	5.30	N
F1206SB5500V024TM	5.5	24		0.014	6.40	U
F1206SB6000V024TM	6.0	24	60 A at rated voltage	0.011	8.50	O
F1206SB7000V024TM	7.0	24		0.010	10.0	P
F1206SB8000V024TM	8.0	24		0.009	16.9	R

1. Measured at ≤ 10% rated current and 25°C ambient. 2. Melting I²t at 0.001 second pre-arcing time. 3. Red Marking Character Code.

SolidMatrix[®] Surface Mount Fuses
SB Series (Slow Blow), 1206 Size

Average Pre-arcing Time Curves:

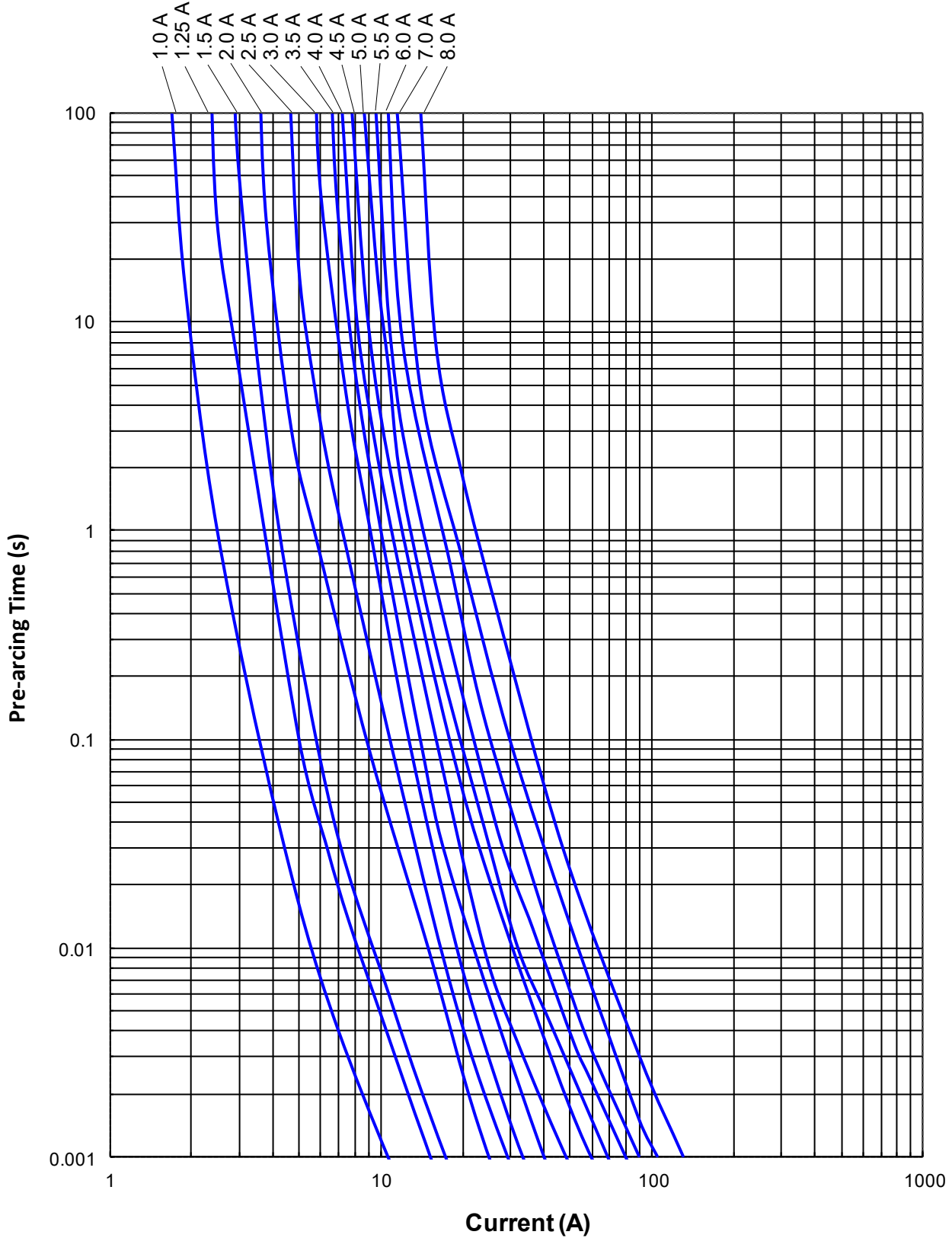

SolidMatrix® Surface Mount Fuses
SB Series (Slow Blow), 1206 Size

Average I^2t vs. t Curves:

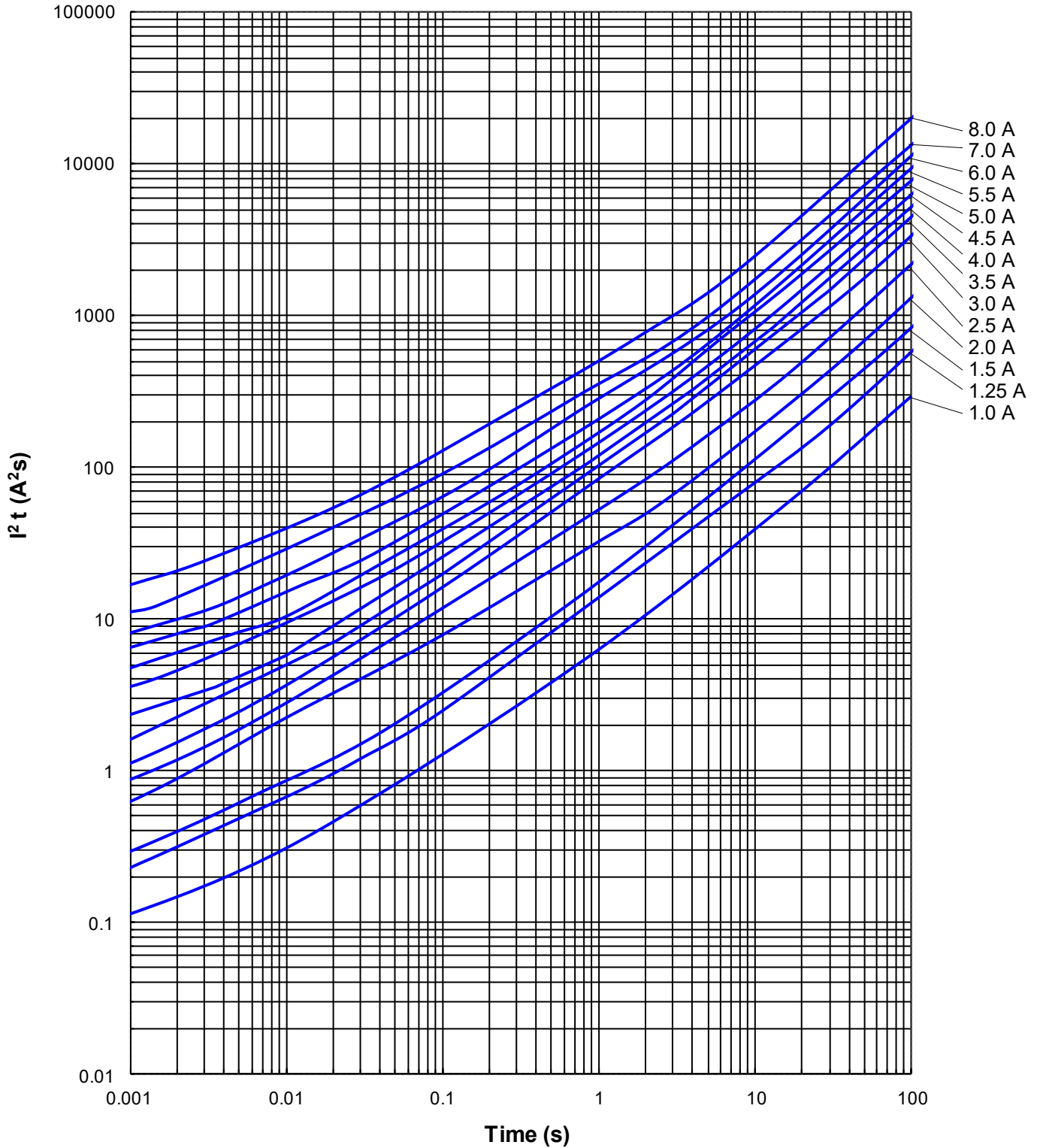

SolidMatrix[®] Surface Mount Fuses

SB Series (Slow Blow), 0603 Size



Features:

- High inrush current withstanding capability
- Ceramic Monolithic structure
- Silver fusing element and silver termination with nickel and tin plating
- Symmetrical design with marking on both sides (optional)
- Operating temperature range: -55°C to +150°C (with de-rating)

Clearing Time Characteristics:

% of Current Rating	Clearing time at 25°C	
	100%	200%
100%	4 hours min.	
200%	1 second min.	120 seconds max.
300%	0.1 seconds min.	3 seconds max.
800% (1 A - 1.5 A)	0.0005 seconds min.	0.05 seconds max.
800% (2 A - 8 A)	0.001 seconds min.	0.05 seconds max.

Shape and Dimensions:

Unit	Inch	mm
L	0.063 ± 0.006	1.60 ± 0.15
W	0.031 ± 0.006	0.80 ± 0.15
T	0.031 ± 0.006	0.80 ± 0.15
B	0.014 ± 0.006	0.36 ± 0.15

Agency Approval:

Recognized Under the Components Program of UL.
 File Number: E232989.

Applications:

- Power tools
- DC-DC convert
- Panel
- PC & NB
- Server
- Battery pack
- Set top box

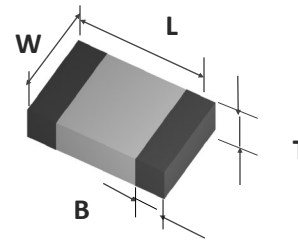

Ordering Information:

Part Number	Current Rating (A)	Voltage Rating (Vdc)	Interrupting Ratings	Nominal Cold DCR (Ω) ¹	Nominal I^2t (A^2s) ²	Marking (Optional) ³
F0603SB1000V032TM	1.0	32	50A at rated voltage	0.200	0.093	E
F0603SB1500V032TM	1.5	32		0.100	0.18	G
F0603SB2000V032TM	2.0	32		0.052	0.32	I
F0603SB2500V032TM	2.5	32		0.041	0.63	J
F0603SB3000V032TM	3.0	32		0.031	0.87	K
F0603SB3500V032TM	3.5	32		0.021	1.20	L
F0603SB4000V032TM	4.0	32		0.017	2.30	M
F0603SB4500V032TM	4.5	32		0.015	2.70	T
F0603SB5000V032TM	5.0	32	0.013	3.20	N	
F0603SB6000V032TM	6.0	32	80A at rated voltage	0.010	4.00	O
F0603SB7000V032TM	7.0	32		0.008	5.00	P
F0603SB8000V032TM	8.0	32		0.006	7.00	R

1. Measured at $\leq 10\%$ rated current and 25°C ambient.

2. Melting I^2t at 0.001 second pre-arcing time.

3. Red Marking Character Code.

SolidMatrix[®] Surface Mount Fuses
SB Series (Slow Blow), 0603 Size

Average Pre-arcing Time Curves:

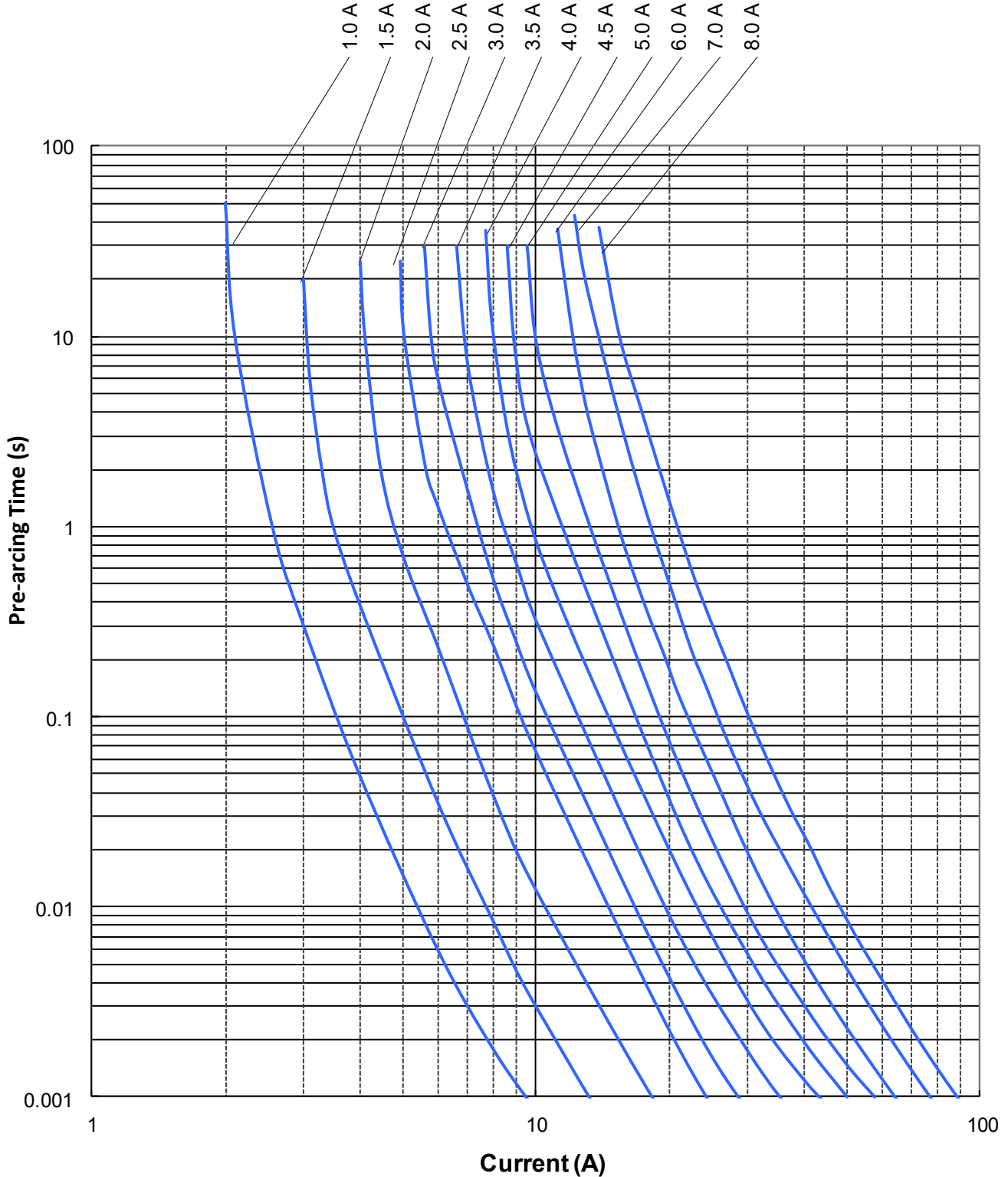

SolidMatrix® Surface Mount Fuses
SB Series (Slow Blow), 0603 Size

Average I^2t vs. t Curves:

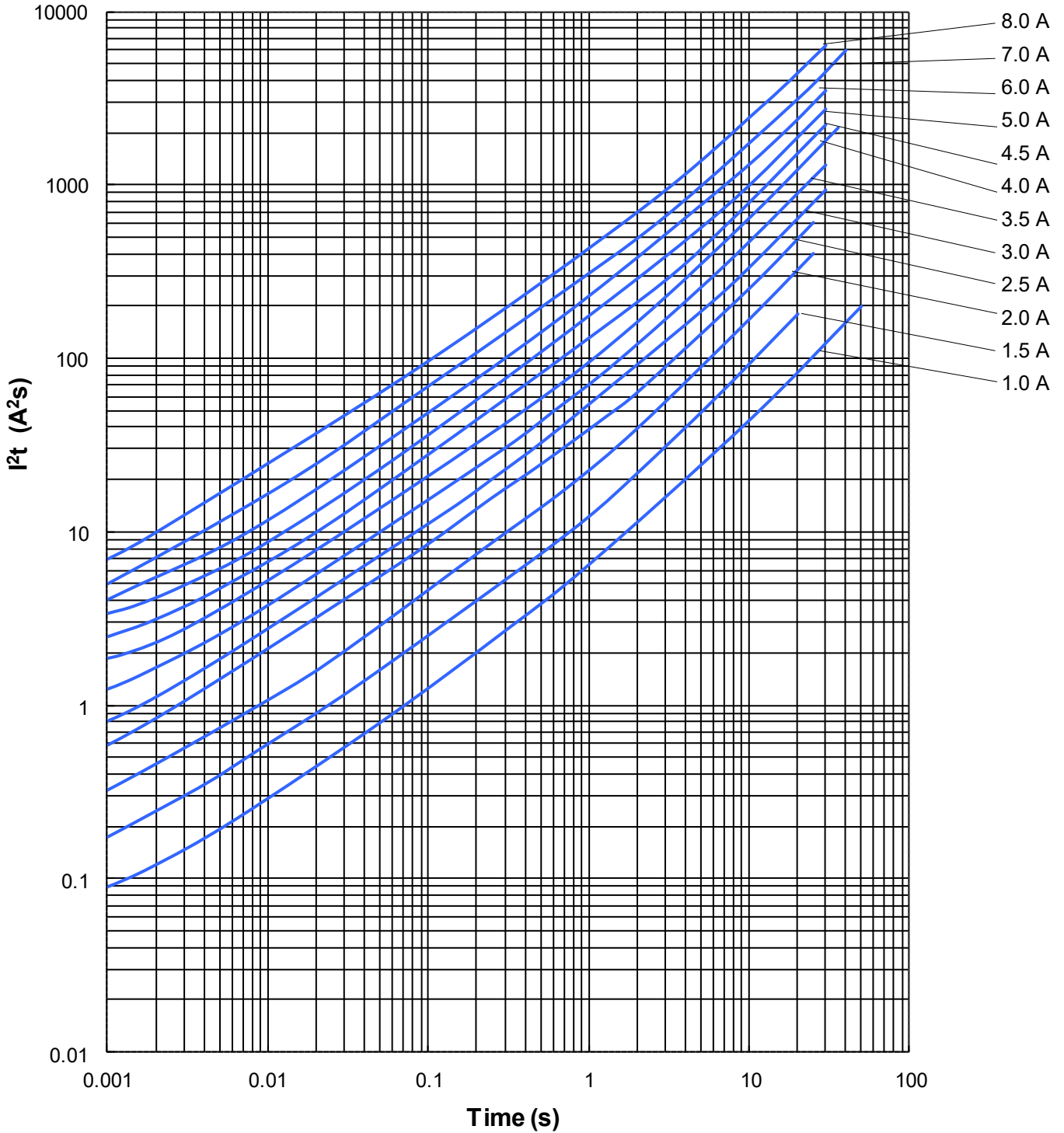

SolidMatrix® Surface Mount Fuses

HI Series (High Inrush), 1206 Size



Features:

- High inrush current withstanding capability
- Ceramic Monolithic structure
- Silver fusing element and silver termination with nickel and tin plating
- Symmetrical design with marking on both sides (optional)
- Operating temperature range: -55°C to +150°C (with de-rating)

Clearing Time Characteristics:

% of Current Rating	Clearing time at 25°C	
	Min.	Max.
100%	4 hours min.	
200% (1.0 A -8.0A)	1 second min.	60 seconds max.
350% (0.5 A -0.75 A)		5 seconds max.
1000% (0.5 A -5.0 A)	0.0002 seconds min.	0.02 seconds max.
1000% (6.0 A -8.0 A)	0.0002 seconds min.	0.04 seconds max.

Shape and Dimensions:

Unit	Inch	mm
L	0.126 ± 0.008	3.20 ± 0.20
W	0.063 ± 0.008	1.60 ± 0.20
T	0.038 ± 0.008	0.97 ± 0.20
B	0.020 ± 0.010	0.51 ± 0.25

Agency Approval:

Recognized Under the Components Program of UL.
 File Number: E232989.

Applications:

- Power tools
- DC-DC convert
- Display
- PC & NB
- Server
- Battery pack
- Set top box

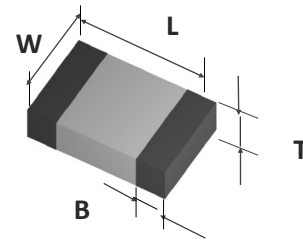

Ordering Information:

Part Number	Current Rating (A)	Voltage Rating (Vdc)	Interrupting Ratings	Nominal Cold DCR (Ω) ¹	Nominal I ² t (A ² s) ²	Marking Code ³
F1206HI0500V065TM	0.5	65	50A at rated voltages	1.000	0.035	C
F1206HI0750V065TM	0.75	65		0.420	0.10	D
F1206HI1000V063TM	1.0	63		0.340	0.11	E
F1206HI1500V063TM	1.5	63		0.150	0.33	G
F1206HI2000V063TM	2.0	63		0.090	0.80	I
F1206HI2500V032TM	2.5	32		0.065	1.19	J
F1206HI3000V032TM	3.0	32		0.035	1.35	K
F1206HI3500V032TM	3.5	32		0.029	1.84	L
F1206HI4000V032TM	4.0	32		0.023	2.74	M
F1206HI4500V032TM	4.5	32		0.021	3.20	T
F1206HI5000V032TM	5.0	32		0.017	5.50	N
F1206HI6000V024TM	6.0	24		80A at rated voltage	0.013	12.5
F1206HI7000V024TM	7.0	24	0.010		30.0	P
F1206HI8000V024TM	8.0	24	0.009		60.0	R

1. Measured at ≤ 10% rated current and 25°C ambient. 2. Melting I²t at 1000% of current rating. 3. Green Marking Character Code.

SolidMatrix[®] Surface Mount Fuses
HI Series (High Inrush), 1206 Size

Average Pre-arcing Time Curves:

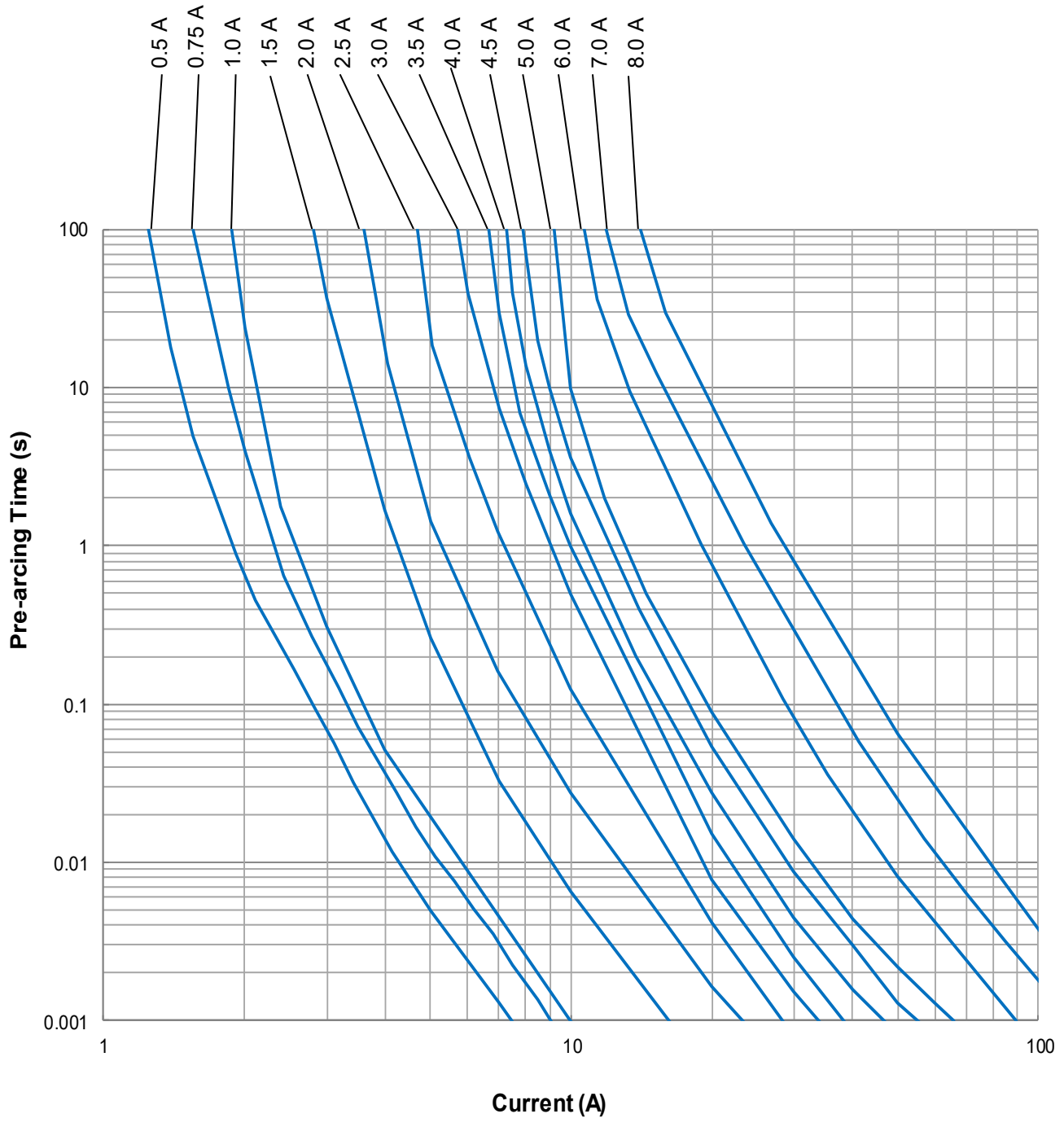

SolidMatrix® Surface Mount Fuses
HI Series (High Inrush), 1206 Size

Average I^2t vs. t Curves:

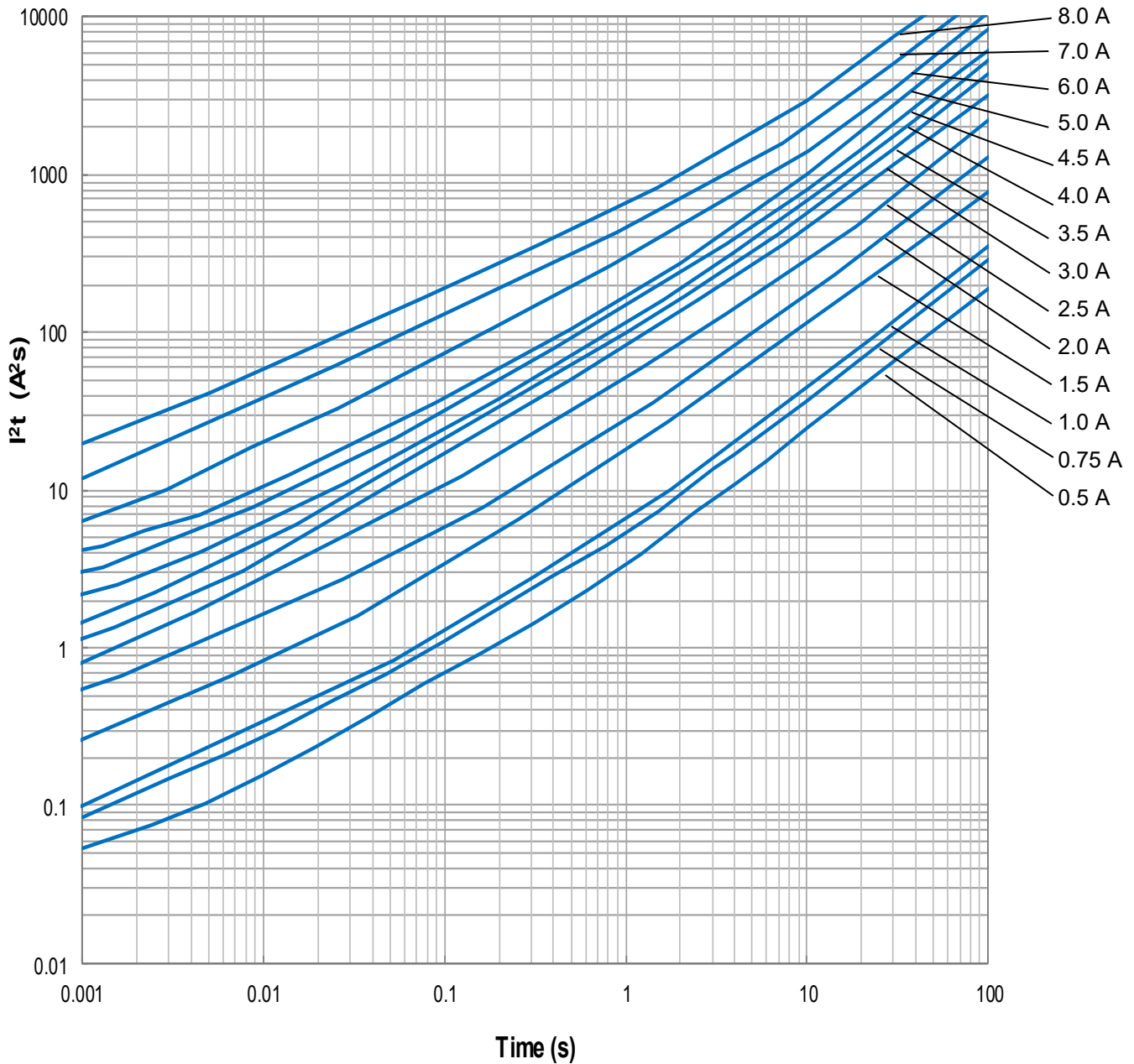

SolidMatrix® Surface Mount Fuses

HI Series (High Inrush), 0603 Size



Features:

- High inrush current withstanding capability
- Ceramic Monolithic structure
- Silver fusing element and silver termination with nickel and tin plating
- Symmetrical design with marking on both sides (optional)
- Operating temperature range: -55°C to +150°C (with de-rating)

Clearing Time Characteristics:

% of Current Rating	Clearing time at 25°C	
	100%	200%
100%	4 hours min.	
200%	1 second min.	60 seconds max.
1000% (1-5A)	0.0002 seconds min.	0.02 seconds max.

Shape and Dimensions:

Unit	Inch	mm
L	0.063 ± 0.006	1.60 ± 0.15
W	0.031 ± 0.006	0.80 ± 0.15
T	0.031 ± 0.006	0.80 ± 0.15
B	0.014 ± 0.006	0.36 ± 0.15

Agency Approval:

Recognized Under the Components Program of UL.
 File Number: E232989.

Applications:

- Power tools
- DC-DC convert
- Panel
- PC
- Server
- Battery pack
- Set top box

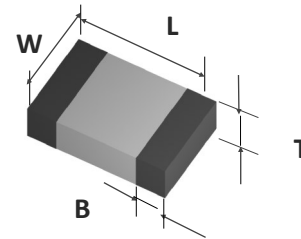

Ordering Information:

Part Number	Current Rating (A)	Voltage Rating (Vdc)	Interrupting Ratings	Nominal Cold DCR (Ω) ¹	Nominal I^2t (A^2s) ²	Marking (Optional) ³
F0603HI1000V032TM	1.0	32	50A at rated voltage	0.210	0.08	E
F0603HI1500V032TM	1.5	32		0.101	0.11	G
F0603HI2000V032TM	2.0	32		0.057	0.24	I
F0603HI2500V032TM	2.5	32		0.042	0.56	J
F0603HI3000V032TM	3.0	32		0.030	0.72	K
F0603HI3500V032TM	3.5	32		0.022	1.10	L
F0603HI4000V032TM	4.0	32		0.018	2.08	M
F0603HI4500V032TM	4.5	32		0.014	2.63	T
F0603HI5000V032TM	5.0	32		0.013	3.25	N
F0603HI6000V032TM	6.0	32	70A at rated voltage	0.010	4.00	O
F0603HI7000V032TM	7.0	32	80A at rated voltage	0.008	5.00	P
F0603HI8000V032TM	8.0	32		0.006	7.00	R

1. Measured at $\leq 10\%$ rated current and 25°C ambient. 2. Melting I^2t at 1000% of current rating. 3. Green Marking Character Code.

SolidMatrix[®] Surface Mount Fuses

HI Series (High Inrush), 0603 Size

Average Pre-arcing Time Curves:

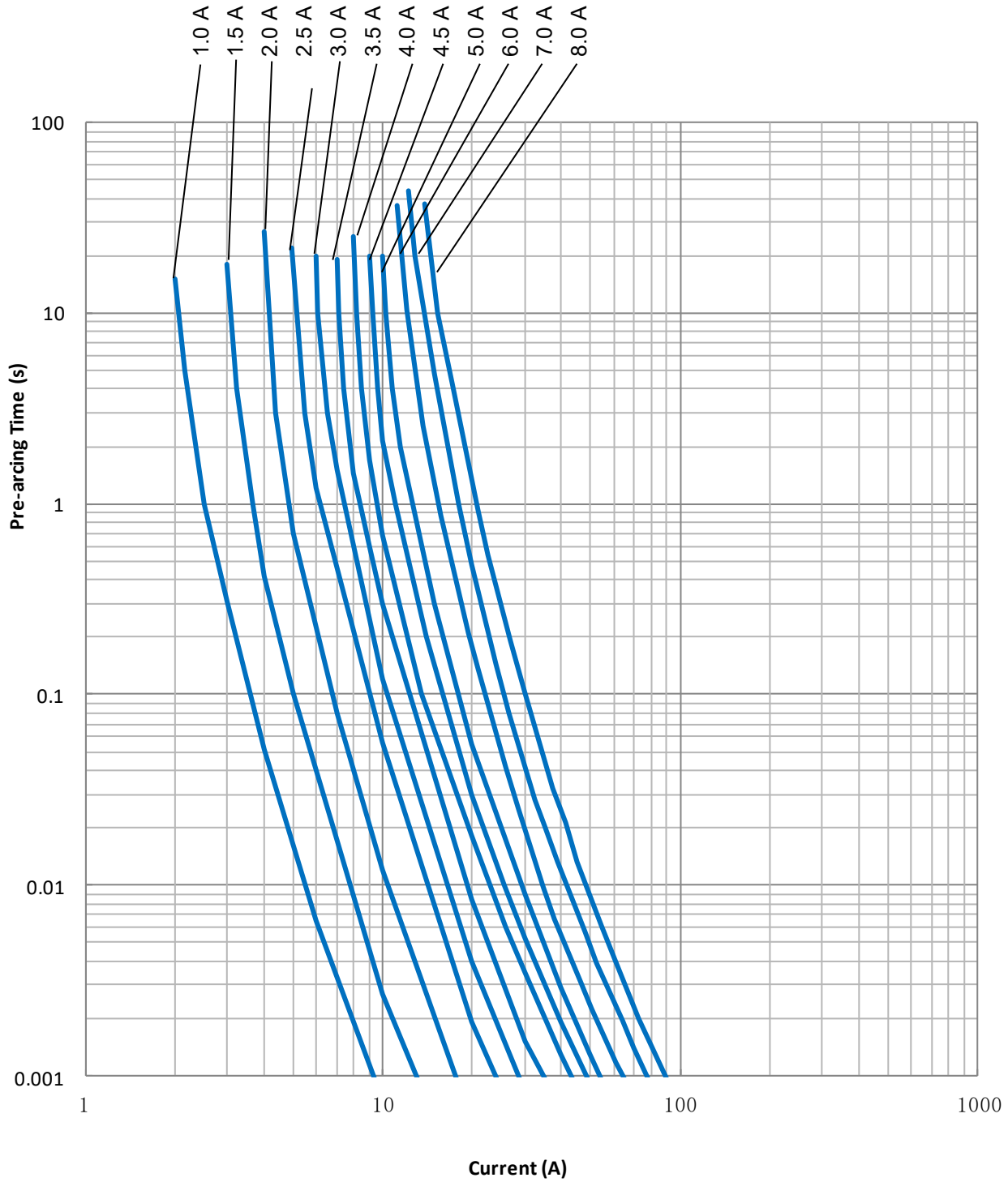

SolidMatrix® Surface Mount Fuses
HI Series (High Inrush), 0603 Size

Average I^2t vs. t Curves:

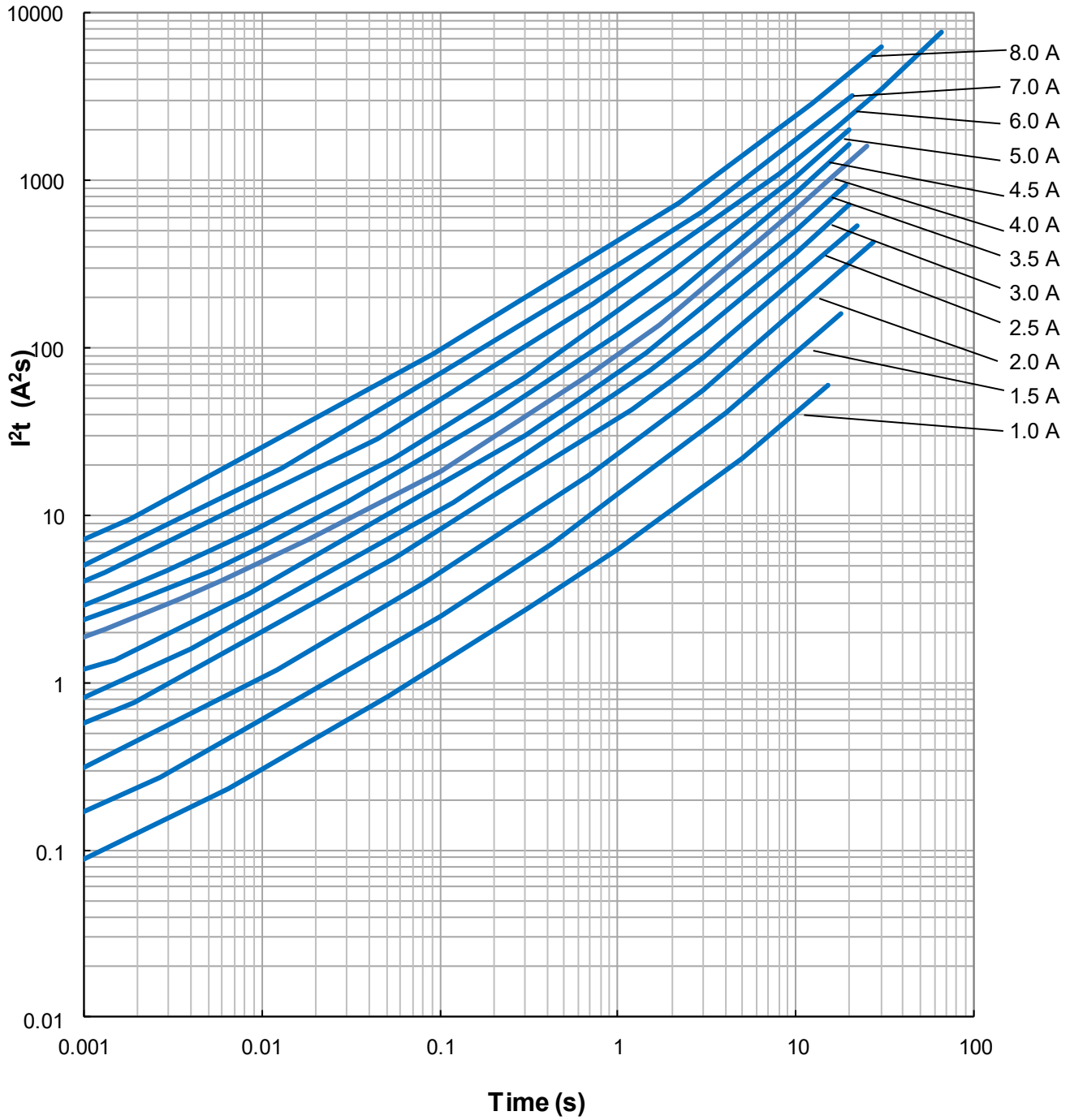

SolidMatrix[®] Surface Mount Fuses

HA Series (High Current), 1206 Size



Features:

- Special products for high current rating applications
- Glass ceramic monolithic structure
- Silver fusing element and silver termination with nickel and tin plating
- RoHS compliant and lead-free materials
- Superior arc suppression capability
- High current ratings
- Symmetrical design with marking on both sides (optional)
- Operating temperature range: -55°C to 150°C (with de-rating)

Clearing Time Characteristics:

% of current rating	Clearing time at 25°C
100%	4 hours min.
250%	5 seconds max.

Shape and Dimensions:

Unit	Inch	mm
L	0.126 ± 0.008	3.20 ± 0.20
W	0.063 ± 0.008	1.60 ± 0.20
T	0.038 ± 0.008	0.97 ± 0.20
B	0.020 ± 0.010	0.51 ± 0.25

Agency Approval:

Recognized Under the Components Program of UL.
 File Number: E232989.

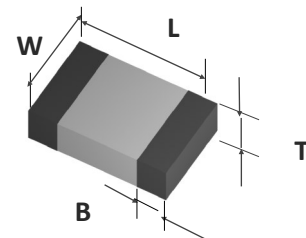

Applications:

- Power tools
- DC-DC convert
- Display
- PC & Notebook
- Server
- Battery pack

Ordering Information:

Part Number	Current Rating (A)	Voltage Rating (Vdc)	Interrupting Ratings	Nominal Cold DCR (Ω) ¹	Nominal I^2t (A^2s) ²	Marking Code ³
F1206HA10V024TM	10	24	100A@24Vdc	0.010	9	Q
F1206HA12V024TM	12	24		0.008	14	X
F1206HA15V024TM	15	24		0.005	26	Y
F1206HA20V024TM	20	24		0.003	56	Z

1. Measured at $\leq 10\%$ rated current and 25°C ambient.

2. Melting I^2t at 0.001 second pre-arcing time

SolidMatrix[®] Surface Mount Fuses
HA Series (High Current), 1206 Size

Average Pre-arcing Time Curves:

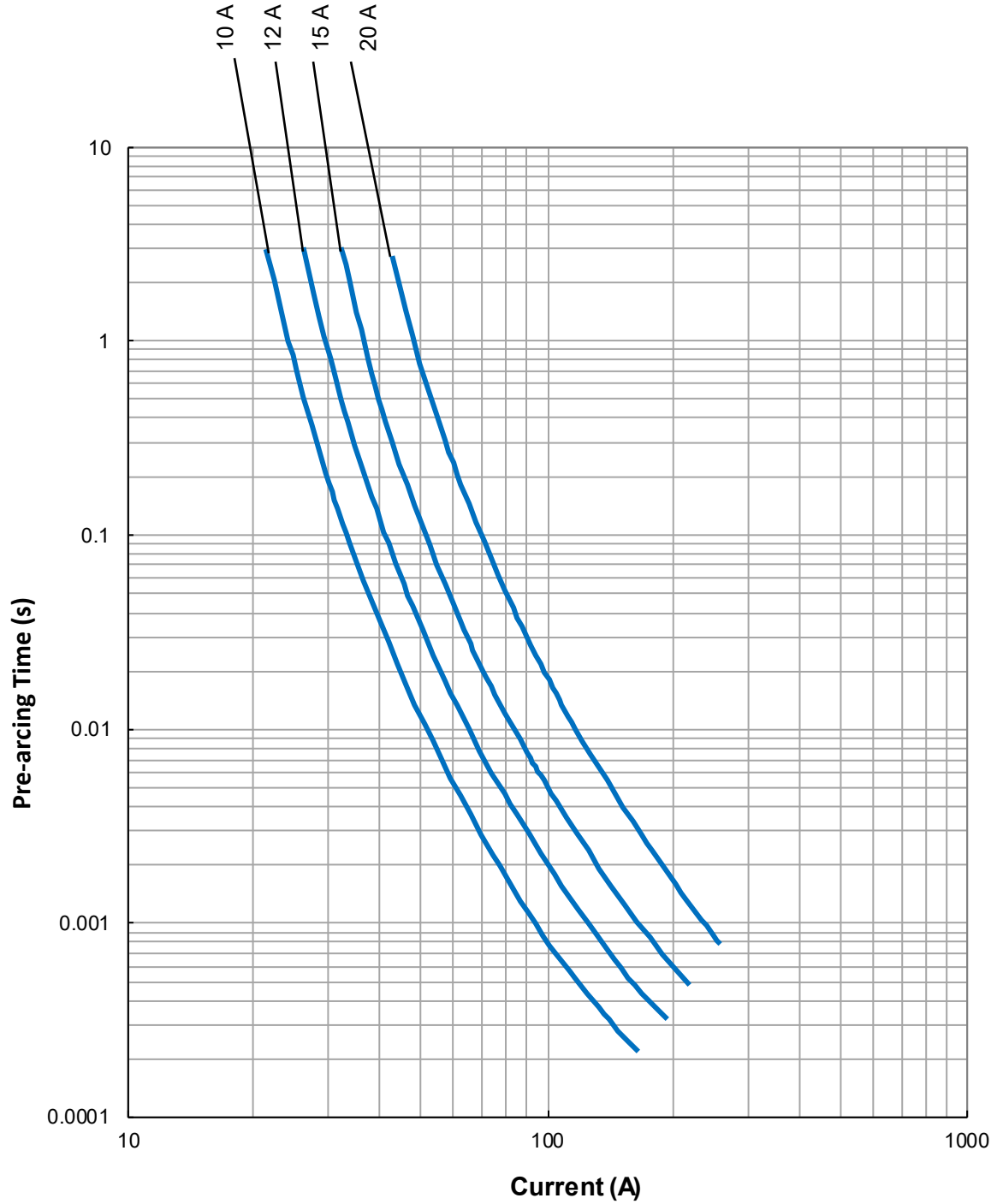

SolidMatrix[®] Surface Mount Fuses
HA Series (High Current), 1206 Size

Average I^2t vs. t Curves:

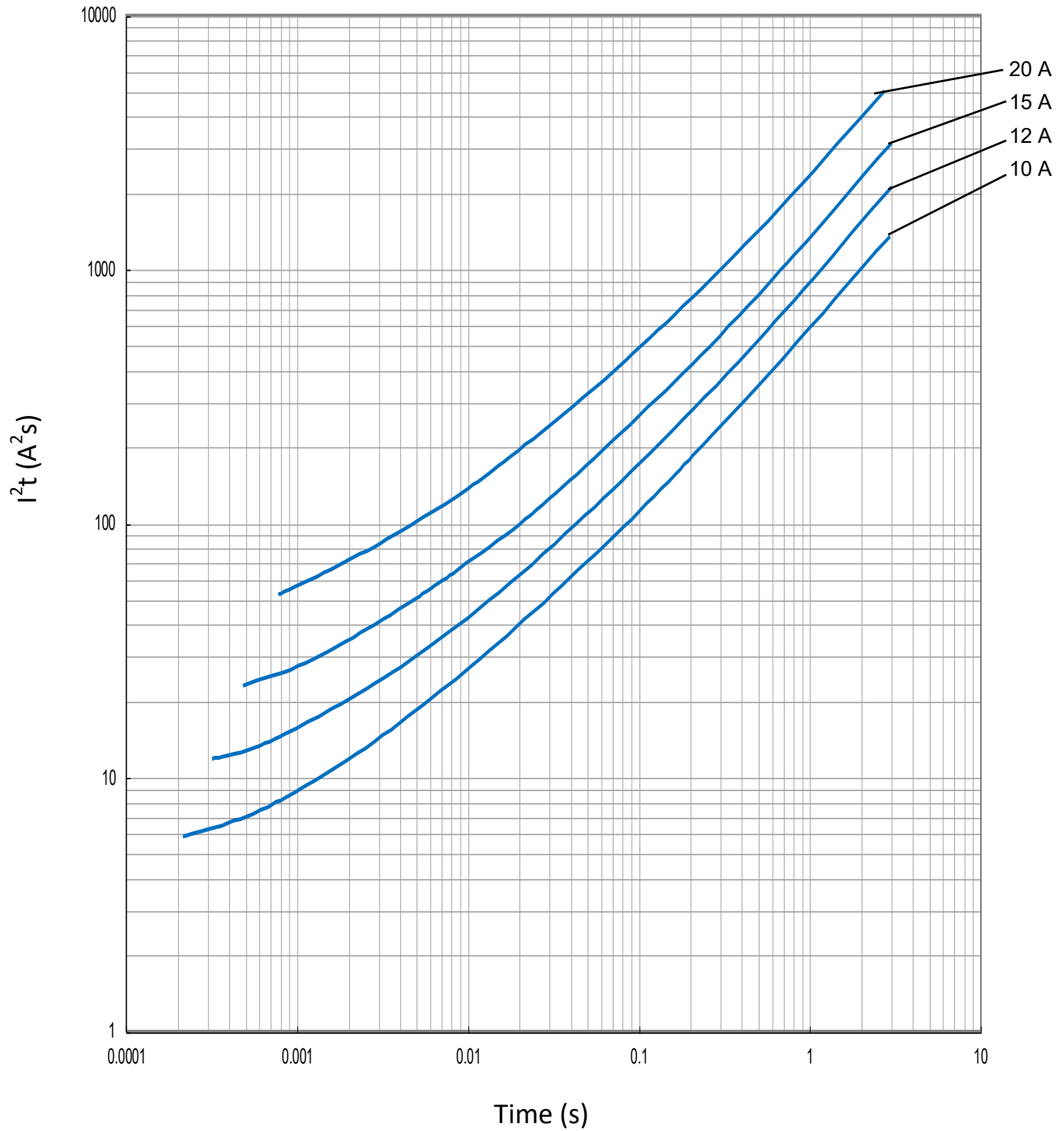

SolidMatrix® Surface Mount Fuses

HB Series (High Current), 1206 Size



Features:

- Special products for high current rating applications
- Higher current ratings and excellent inrush current withstanding capability (high I^2t)
- Glass ceramic monolithic structure
- Silver fusing element and silver termination with nickel and tin plating
- Superior arc suppression capability
- Symmetrical design with marking on both sides (optional)
- Operating temperature range: -55°C to 150°C (with de-rating)

Clearing Time Characteristics:

% of current rating	Clearing time at 25°C
100%	4 hours min.
350%	5 seconds max.

Shape and Dimensions:

Unit	Inch	mm
L	0.126 ± 0.008	3.20 ± 0.20
W	0.063 ± 0.008	1.60 ± 0.20
T	0.038 ± 0.008	0.97 ± 0.20
B	0.020 ± 0.010	0.51 ± 0.25

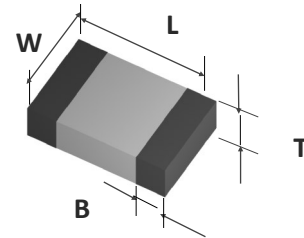

Agency Approval:

Recognized Under the Components Program of UL.
 File Number: E232989.

Applications:

- Power tools
- DC-DC convert
- Display
- PC & Notebook
- Server
- Battery pack

Ordering Information:

Part Number	Current Rating (A)	Voltage Rating (Vdc)	Interrupting Ratings	Nominal Cold DCR(Ω) ¹	Nominal I^2t (A^2s) ²	Marking Code ³
F1206HB10V024TM	10	24	150 A at rated voltage	0.0045	12	Q
F1206HB12V024TM	12	24		0.0039	19	X
F1206HB15V024TM	15	24	200 A at rated voltage	0.0031	34	Y
F1206HB20V024TM	20	24		0.0020	64	Z
F1206HB25V024TM	25	24	250 A at rated voltage	0.0016	187	S
F1206HB30V024TM	30	24	300 A at rated voltage	0.0012	270	V

1. Measured at $\leq 10\%$ rated current and 25°C ambient.

2. Melting I^2t at 1000% of current rating.

3. Red Marking Character Code.

SolidMatrix[®] Surface Mount Fuses
HB Series (High Current), 1206 Size

Average Pre-arcing Time Curves:

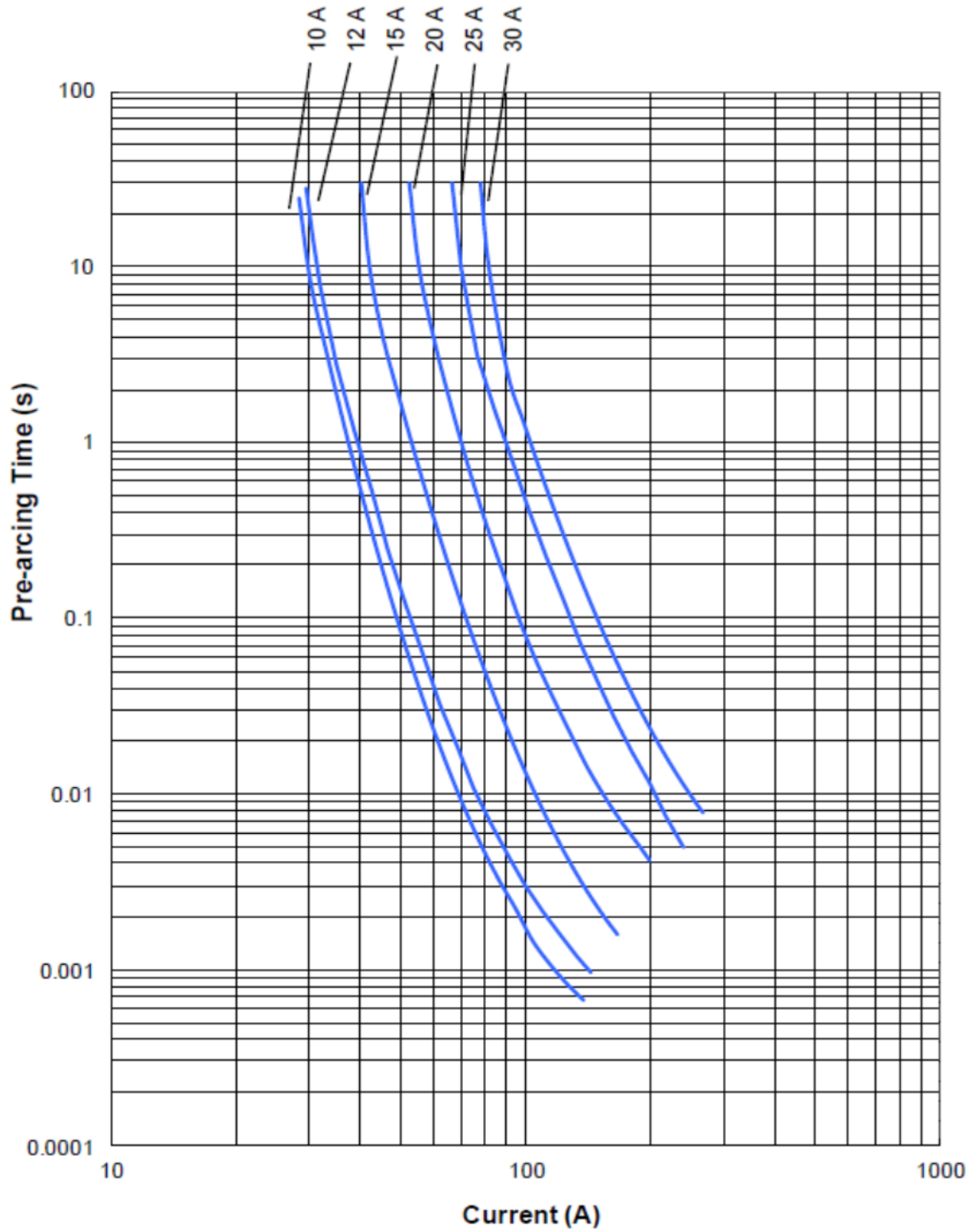

SolidMatrix[®] Surface Mount Fuses
HB Series (High Current), 1206 Size

Average I^2t vs. t Curves:

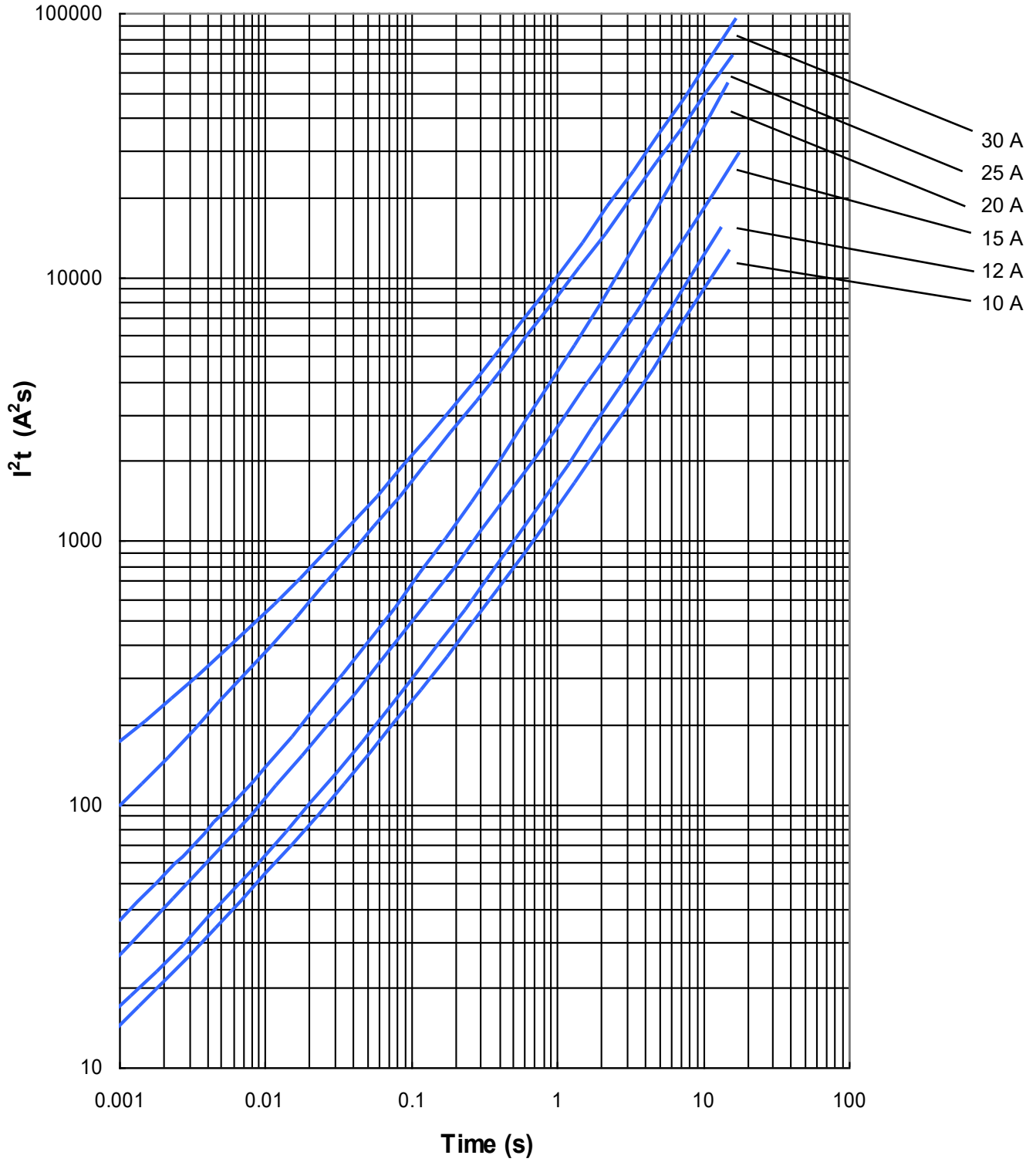

SolidMatrix® Surface Mount Fuses

HC Series (High Current), 1206 Size



Features:

- High inrush current withstanding capability at high voltage
- Glass ceramic monolithic structure
- Sliver fusing element and silver termination with nickel and tin plating
- Superior arc suppression capability
- RoHS compliant and lead free materials
- Operating temperature range: -55°C to +150°C (with de-rating)

Shape and Dimensions:

Unit	Inch	mm
L	0.126 ± 0.008	3.20 ± 0.20
W	0.063 ± 0.008	1.60 ± 0.20
T1	0.038 ± 0.008	0.97 ± 0.20
T2	0.051 ± 0.008	1.30 ± 0.20
B	0.020 ± 0.010	0.51 ± 0.25

T1: Thickness for 10-25A;
 T2: Thickness for 30-40A.

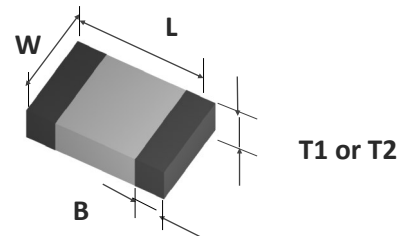

Clearing Time Characteristics:

% of current rating	Clearing time at 25°C
100%	4 hours min.
350%	5 seconds max.

Agency Approval:

Recognized Under the Components Program of UL.
 File Number: E232989.

Applications:

- Power tools
- DC-DC convert
- Display
- PC & Notebook
- Server
- Battery pack

Ordering Information:

Part Number	Current Rating (A)	Voltage Rating Vdc)	Interrupting Ratings	Nominal Cold DCR(Ω) ¹	Nominal I ² t (A ² s) ²	Marking Code ³
F1206HC10A0TM	10	35	150A@35Vdc	0.0055	15	Q
F1206HC12A0TM	12	35		0.0045	20	X
F1206HC15A0TM	15	35		0.0032	35	Y
F1206HC20A0TM	20	35		0.0023	80	Z
F1206HC25A0TM	25	35	200A@35Vdc	0.0016	120	S
F1206HC30A0TM	30	35	200A@35Vdc; 300A@26Vdc	0.0012	180	V
F1206HC40A0TM	40	35		0.0009	240	O

1. Measured at ≤ 10% rated current and 25°C ambient.

2. Melting I²t at 1000% of current rating.

3. Blue Marking Character Code. Devices designed to be mounted with marking code facing up.

SolidMatrix[®] Surface Mount Fuses

HC Series (High Current), 1206 Size

Average Pre-arcing Time Curves:

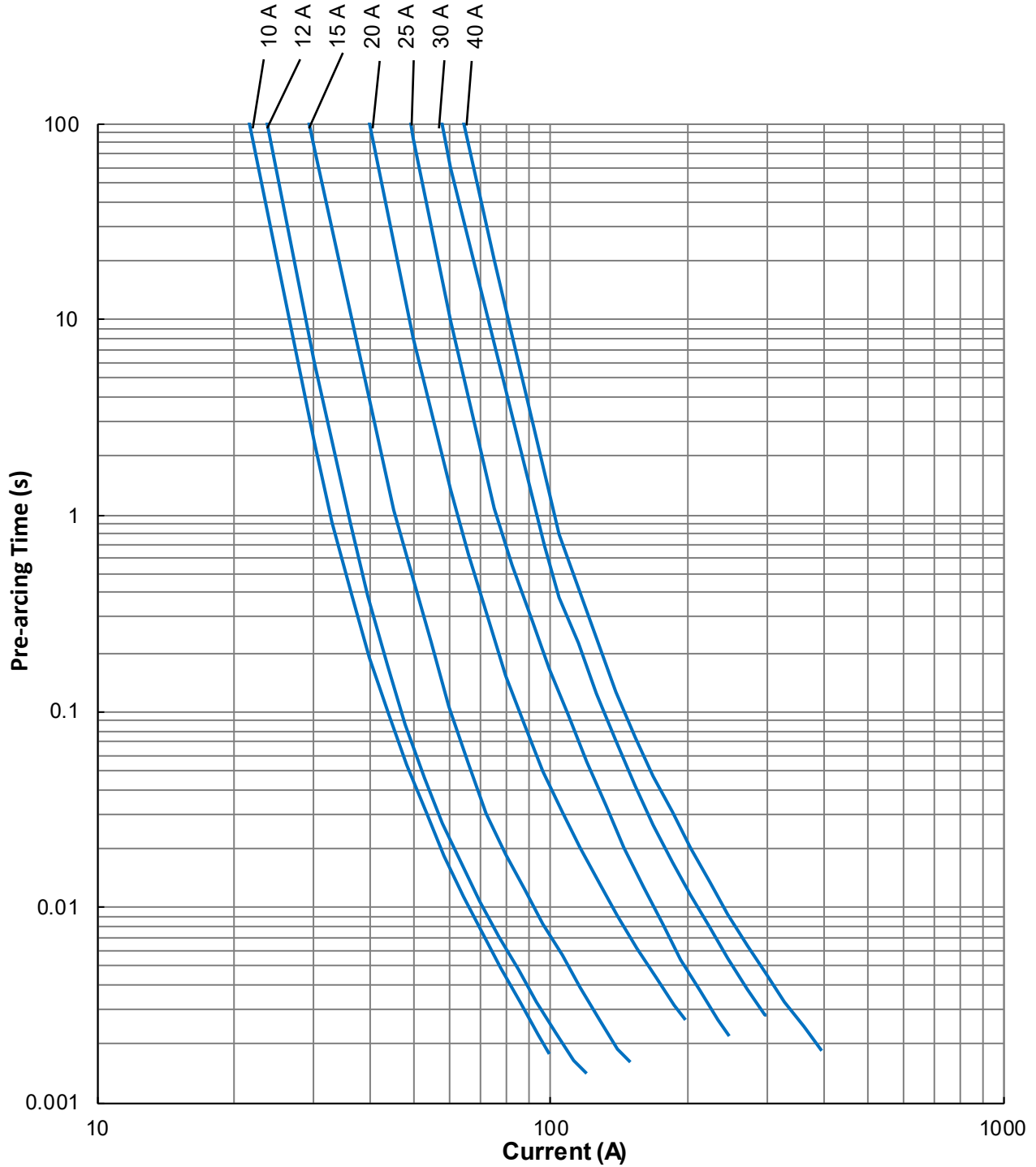

SolidMatrix® Surface Mount Fuses
HC Series (High Current), 1206 Size

Average I^2t vs. t Curves:

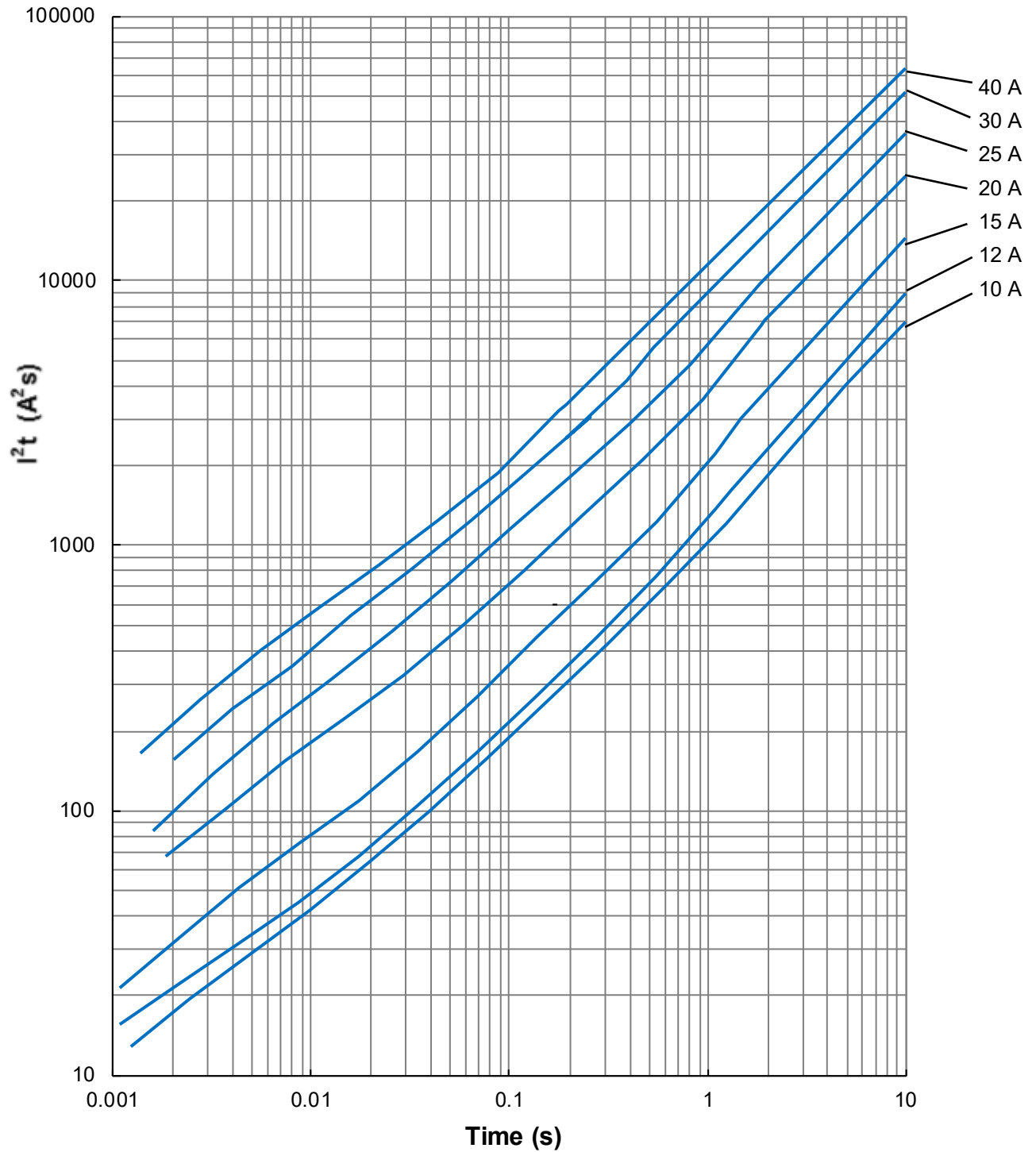

SolidMatrix® Surface Mount Fuses

FF Series (Very Fast Acting), 0603 Size



Features:

- Very fast acting at 200% and 300% overloads
- Excellent inrush current withstanding capability at high overloads
- Thin body for space limiting applications
- Glass ceramic monolithic structure
- Silver fusing element and silver termination with nickel and tin plating
- Symmetrical design with marking on both sides (optional)
- Operating temperature range: -55°C to +150°C (with de-rating)

Clearing Time Characteristics:

% of Current Rating	Clearing Time at 25°C	
	100%	4 hours min.
200%	0.01 seconds min.	5 seconds max.
300%	0.001 seconds min.	0.2 seconds max.

Shape and Dimensions:

Unit	Inch	mm
L	0.063 ± 0.006	1.60 ± 0.15
W	0.031 ± 0.006	0.80 ± 0.15
T	0.012 + 0.007 / -0.003	0.30 + 0.18 / -0.08
B	0.014 ± 0.006	0.36 ± 0.15

Agency Approval:

Recognized Under the Components Program of UL.
 File Number: E232989.

Applications:

- Panel
- Notebook
- Toy
- IoT
- Infotainment System
- Battery pack

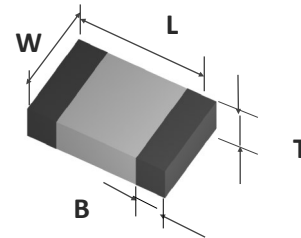

Ordering Information:

Part Number	Current Rating (A)	Voltage Rating Vdc	Interrupting Ratings	Nominal Cold DCR (Ω) ¹	Nominal I ² t (A ² s) ²	Marking (Optional) ³
F0603FF0500V032TM	0.5	32	50A at rated voltage	1.000	0.0093	C
F0603FF0750V032TM	0.75	32		0.450	0.0191	D
F0603FF1000V032TM	1.0	32		0.280	0.036	E
F0603FF1250V032TM	1.25	32	35A at rated voltage	0.205	0.063	F
F0603FF1500V032TM	1.5	32		0.143	0.095	G
F0603FF1750V032TM	1.75	32		0.095	0.14	H
F0603FF2000V032TM	2.0	32		0.073	0.21	I
F0603FF2500V032TM	2.5	32		0.046	0.30	J
F0603FF3000V032TM	3.0	32		0.039	0.46	K
F0603FF3500V032TM	3.5	32		0.028	0.73	L
F0603FF4000V032TM	4.0	32		0.023	1.15	M
F0603FF4500V032TM	4.5	32		0.019	1.68	T
F0603FF5000V032TM	5.0	32		0.015	2.62	N

1. Measured at ≤ 10% rated current and 25°C ambient. 2. Melting I²t at 0.001 second pre-arcing time. 3. Blue Marking Character Code.

SolidMatrix® Surface Mount Fuses
FF Series (Very Fast Acting), 0603 Size

Average Pre-arcing Time Curves:

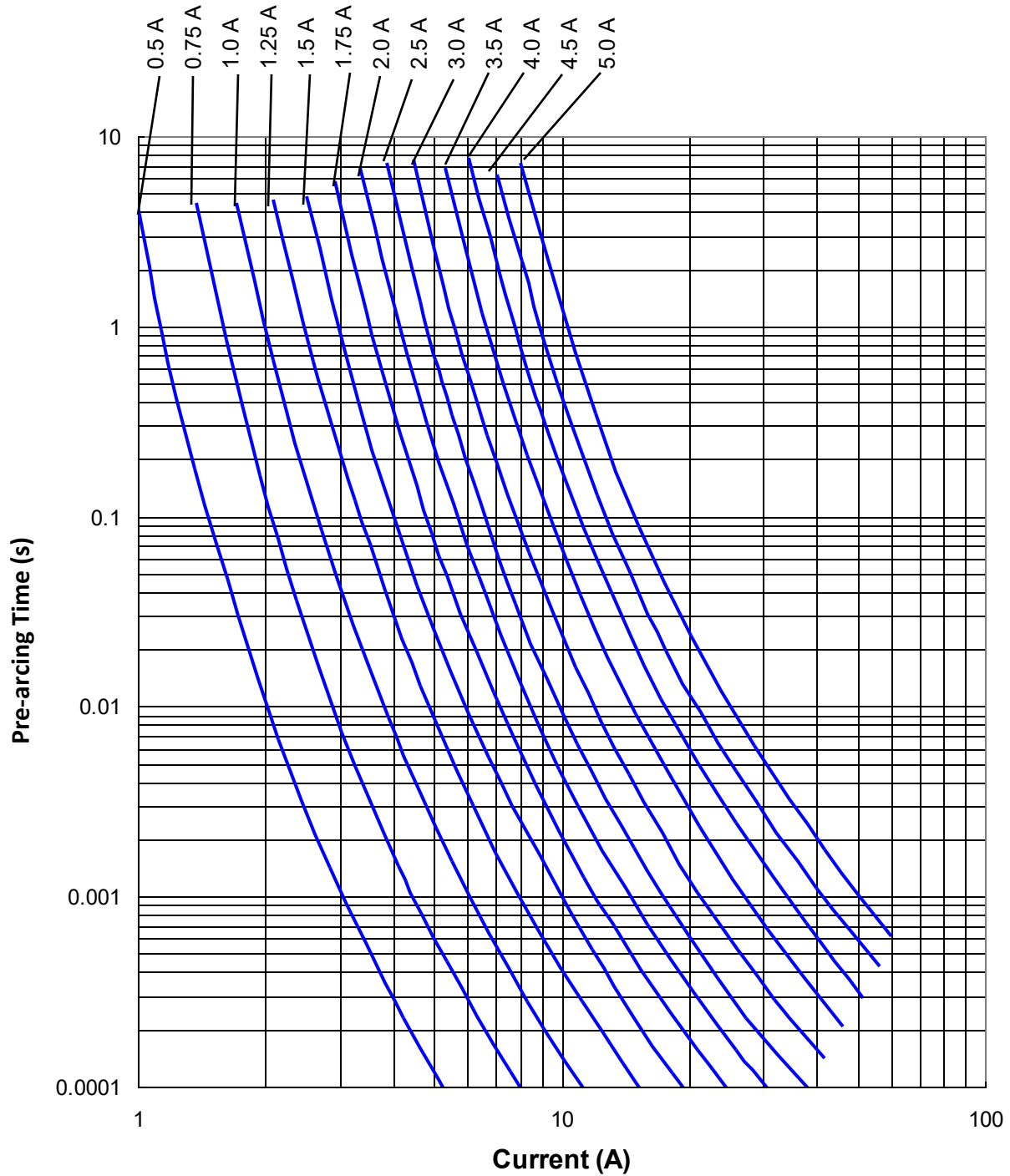

SolidMatrix® Surface Mount Fuses
FF Series (Very Fast Acting), 0603 Size

Average I^2t vs. t Curves:

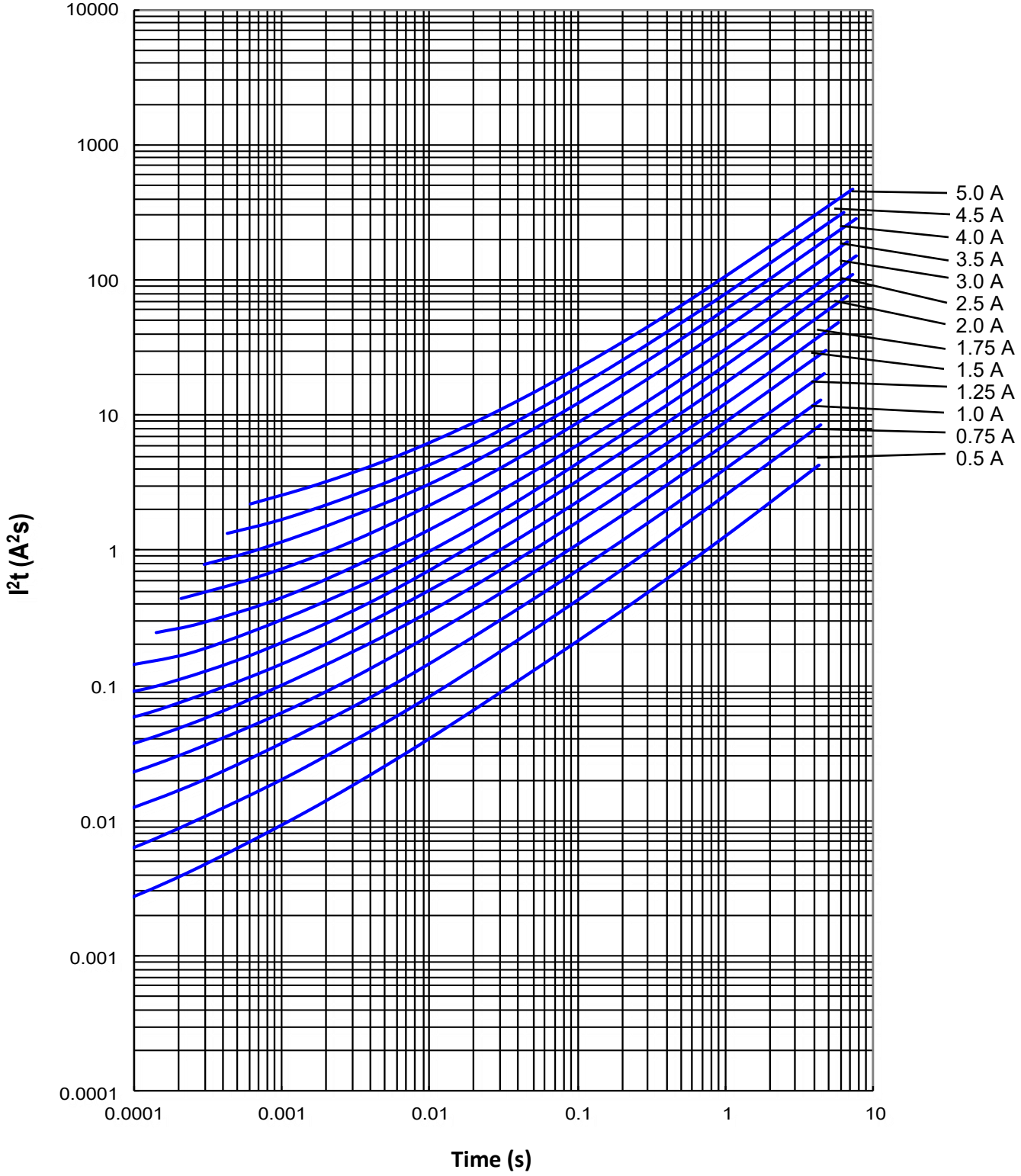

SolidMatrix® Surface Mount Fuses

VH Series (Voltage High), 1206 Size

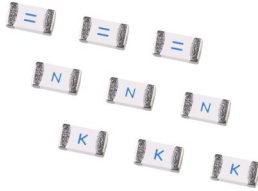

Features:

- High inrush current withstanding capability
- Ceramic Monolithic structure
- Silver fusing element and silver termination with nickel and tin plating
- Symmetrical design with marking on both sides (optional)
- Operating temperature range: -55°C to +125°C (with de-rating)

Clearing Time Characteristics:

% of Current Rating	Clearing Time at 25°C	
	4 hours min.	60 seconds max.
100%	4 hours min.	60 seconds max.
200% (2.5 A - 5.0 A)		60 seconds max.
350% (6.0 A - 8.0 A)		5 seconds max.
1000%	0.0002 seconds min.	0.02 seconds max.

Shape and Dimensions:

Unit	Inch	mm
L	0.126 ± 0.008	3.20 ± 0.20
W	0.063 ± 0.008	1.60 ± 0.20
T	0.034 ± 0.008	0.85 ± 0.20
B	0.020 ± 0.010	0.51 ± 0.25

Agency Approval:

Recognized Under the Components Program of UL.
 File Number: E232989.

Applications:

- Power tools
- DC-DC convert
- Display
- PC
- Server
- Battery pack
- Set top box

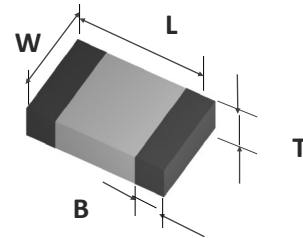

Ordering Information:

Part Number	Current Rating (A)	Voltage Rating (Vdc)	Interrupting Ratings	Nominal Cold DCR (Ω) ¹	Nominal I ² t (A ² s) ²	Marking ³
F1206VH2500TM	2.5	65V	60A@ 65Vdc 80A@48Vdc 100A@32Vdc	0.065	1.15	J
F1206VH3000TM	3.0			0.042	2.40	K
F1206VH3500TM	3.5			0.033	2.80	L
F1206VH4000TM	4.0			0.026	3.80	M
F1206VH4500TM	4.5			0.024	3.90	T
F1206VH5000TM	5.0			0.018	4.40	N
F1206VH6000TM	6.0	48V	80A@48Vdc 100A@32Vdc	0.011	13.0	+
F1206VH7000TM	7.0			0.009	19.0	-
F1206VH8000TM	8.0			0.007	20.0	=

1. Measured at ≤ 10% rated current and 25°C ambient.
2. Melting I²t at 10 times of rated current.
3. Blue Marking Character Code.

SolidMatrix® Surface Mount Fuses
VH Series (Voltage High), 1206 Size

Average Pre-arcing Time Curves:

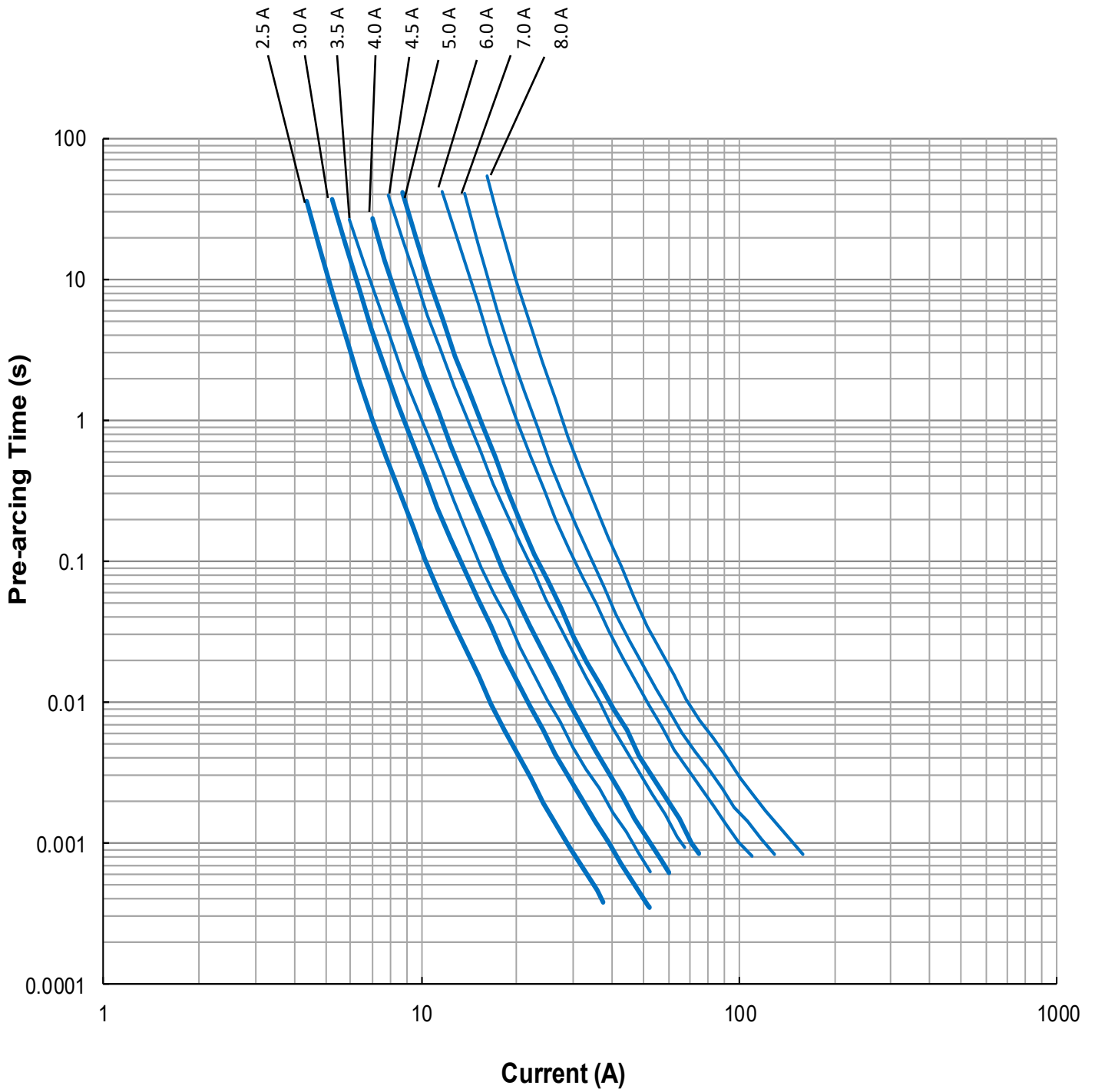

SolidMatrix® Surface Mount Fuses
VH Series (Voltage High), 1206 Size

Average I^2t vs. t Curves:

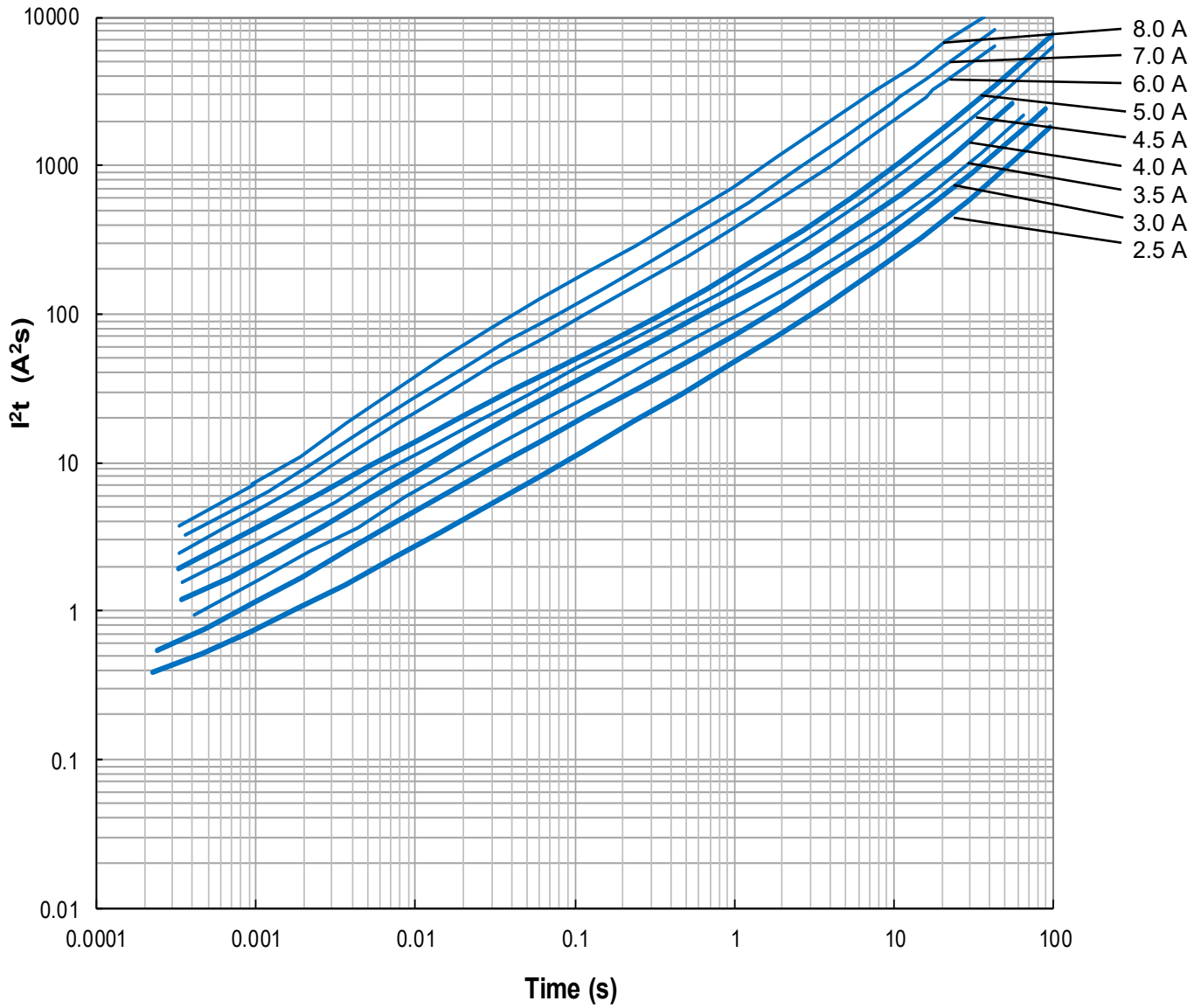

TF-FUSE® Thin Film Surface Mount Fuses

Product Identification:

T 0603 FF 1000 T M

(1) (2) (3) (4) (5) (6)

(1) **Product Code:** T—Thin Film

(2) **Size Code:** Standard EIA chip sizes

(3) **Series Code:** FF—Very Fast Acting, HI—High Inrush

(4) **Current Rating Code:** 0500—0.5A, 1000—1.0A

(5) **Package Code:** T—Tape & Reel; B—Bulk

(6) **Marking Code:** M—With mark (optional)

Environmental Tests:

No.	Test item	Test Condition and Requirement	Reference
1	Bend	2 mm bend, DCR change within $\pm 20\%$. ($\pm 10\%$ for $\leq 1A$), no mechanical damage	IEC60068-2-21
2	Solderability	245°C, 5 seconds, new solder coverage $\geq 95\%$	MIL-STD-202 Method 208
3	Thermal shock	DCR change $\leq \pm 10\%$. No mechanical damage. 100 cycles between -55°C and +125°C	MIL-STD-202 Method 107
4	Moisture resistance	10 cycles, DCR change within $\pm 10\%$, no excessive corrosion	MIL-STD-202 Method 106
5	Salt spray	DCR change $\leq \pm 10\%$. No excessive corrosion. 5% salt solution, 48 hour exposure	MIL-STD-202 Method 101
6	Mechanical vibration	DCR change $\leq \pm 10\%$. No mechanical damage. 0.4" D.A. or 30G between 5 and 3000 Hz	MIL-STD-202 Method 204
7	Mechanical shock	DCR change $\leq \pm 10\%$. No mechanical damage. 1500G, 0.5 ms, half sine shocks	MIL-STD-202 Method 213
8	Life	75% rated current, 2000 hours at ambient temperature from +20°C to 30 °C, no open circuit, voltage drop change within $\pm 10\%$	Refer to AEM QIQ106

Moisture Sensitivity Level 1

Packaging:

Chip Size	Parts on 7 inch (178mm) Reel
0603 (1608)	8,000
0402 (1005)	20,000

TF-FUSE® Thin Film Surface Mount Fuses

Fuse Selection and Temperature De-rating Guideline:

The ambient temperature affects the current carrying capacity of fuses. When a fuse is operating at a temperature higher than 25°C, the fuse shall be “de-rated”.

To select a fuse from the catalog, the following rule may be followed:

Catalog Fuse Current Rating = Nominal Operating Current / 0.75 / % De-rating at the maximum operating temperature.

Example: At maximum operating temperature of 50°C, % De-rating is 90%. The nominal operating current is 2 A. The current rating for fuse selected from the catalog shall be: $2 / 0.75 / 90\% = 2.96$ or 3 A. Specifications and descriptions in this literature are as accurate as known at the time of publish, but are subject to change without notice.

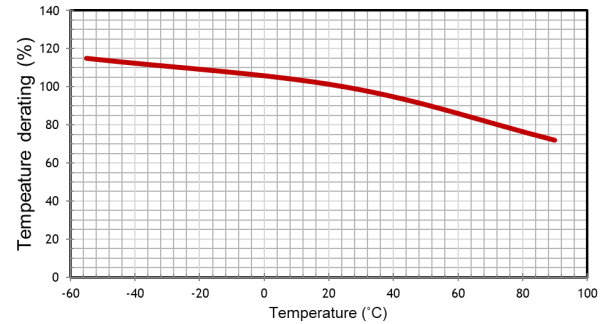

Recommended Reflow Soldering Profile:

Profile Feature	Pb-Free Assembly
Preheat/Soak	
Temperature Min (T_{smin})	150°C
Temperature Max (T_{smax})	200°C
Time (t_s) from (T_{smin} to T_{smax})	60~120 seconds
Ramp-uprate (T_L to T_p)	3°C/second max.
Liquidous temperature (T_L)	217°C
Time (t_L) maintained above T_L	60~150 seconds
Peak package body temperature (T_p)	260°C
Time (t_p)*within 5°C of the specified classification temperature (T_c)	30 seconds *
Ramp-down rate (T_p to T_L)	6°C/second max.
Time 25°C to peak temperature	8 minutes max.
* Tolerance for peak profile temperature (T_p) is defined as a supplier minimum and a user maximum	

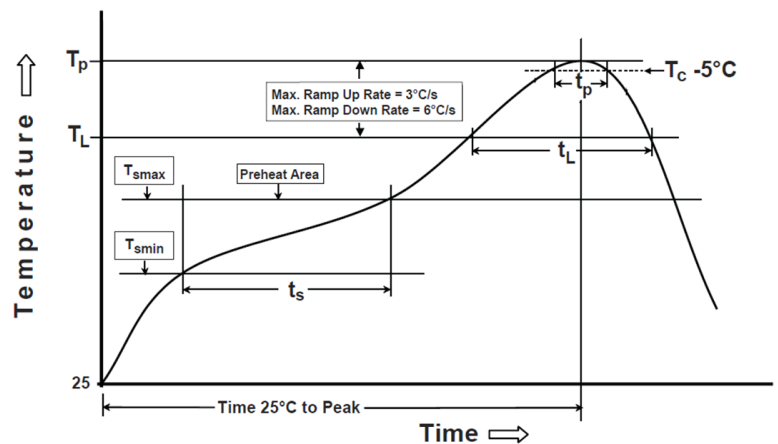

Thermal Shock When Making Correction with a Soldering Iron:

The temperature of solder iron tip should be controlled under 350°C and soldering time should be less than 3 sec.

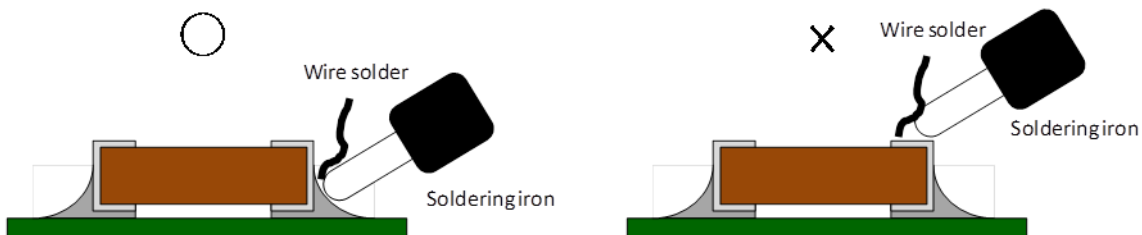
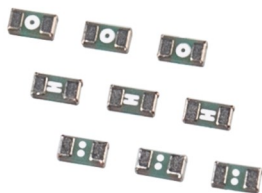

Fig 3 Correct handling method of soldering iron

TF-FUSE® Thin Film Surface Mount Fuses

FF Series (Very Fast Acting), 0402 Size



Features:

- Very fast acting
- Low DCR
- High inrush current withstanding capability
- Fiberglass enforced epoxy fuse body
- Copper termination with nickel and tin plating
- Halogen free, RoHS compliance and lead-free

Clearing Time Characteristics:

% of Current Rating	Ampere Rating	Opening Time at 25°C
100%	0.200A-5.00A	4 hours min.
200%	0.375A-5.00A	5 seconds max.
300%	0.200A-0.250A	5 seconds max.
	0.375A-5.00A	0.2 second max.

Shape and Dimensions:

Unit	Inch	mm
Length (L)	0.039± 0.004	1.00 ± 0.10
Width (W)	0.020 ± 0.004	0.51± 0.10
Thickness (T)	0.013 ± 0.004	0.33 ± 0.10
Termination band-width (b)	0.012 ± 0.004	0.30 ± 0.10

Agency Approval:

Recognized Under the Components Program of UL.
File Number: E232989.

Applications:

- Panel
- Notebook
- Toy
- HDD
- IoT
- Finger print
- Smart lock
- Battery pack

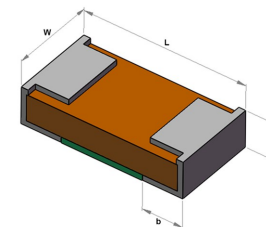

Typical Ratings and Electric Characteristics:

Part Number	Current Rating (A)	Voltage Rating (Vdc)	Interrupting Rating	Nominal Cold DCR (Ω) ¹	Nominal I ² t (A ² s) ²	Marking
T0402FF0200TM	0.200	35	35A@35Vdc	0.60	0.0017	⋯
T0402FF0250TM	0.250	35		:		
T0402FF0375TM	0.375	35		⋯		
T0402FF0500TM	0.50	35				
T0402FF0750TM	0.75	35		—		
T0402FF1000TM	1.00	35		+		
T0402FF1250TM	1.25	35		×		
T0402FF1500TM	1.50	35				
T0402FF1750TM	1.75	35		=		
T0402FF2000TM	2.00	35		≡		
T0402FF2500TM	2.50	35		H		
T0402FF3000TM	3.00	35		III		
T0402FF3500TM	3.50	35		HH		
T0402FF4000TM	4.00	35		□		
T0402FF5000TM	5.00	35		○		

¹ Measured at ≤ 10% of rated current and 25°C ambient . ² Melting I²t at 0.001 second of current rating.

Operating temperature: -55 to +90°C

TF-FUSE® Thin Film Surface Mount Fuses
FF Series (Very Fast Acting), 0402 Size

Average Pre-arcing Time Curves:

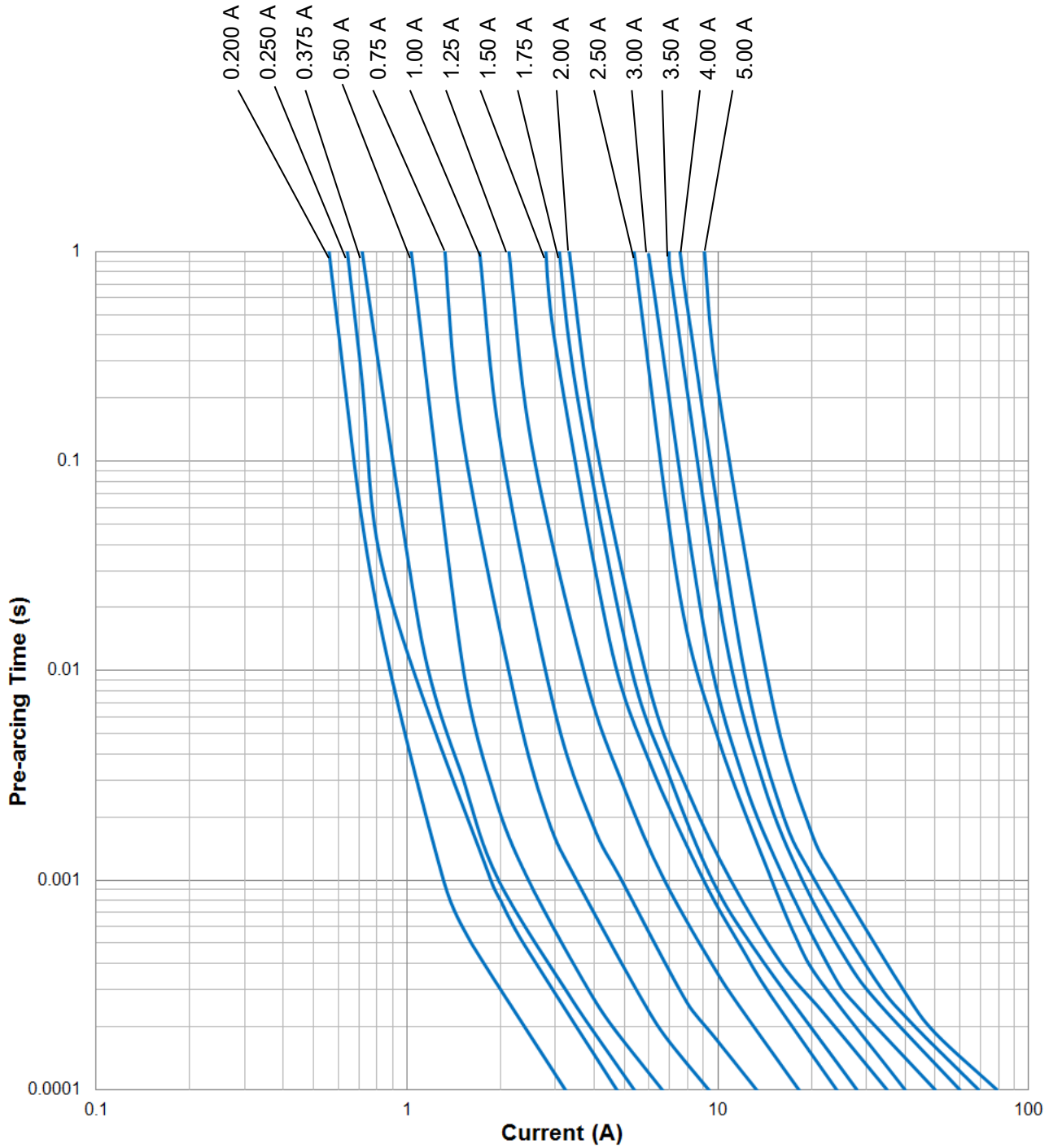

TF-FUSE® Thin Film Surface Mount Fuses
FF Series (Very Fast Acting), 0402 Size

Average I^2t vs. t Curves:

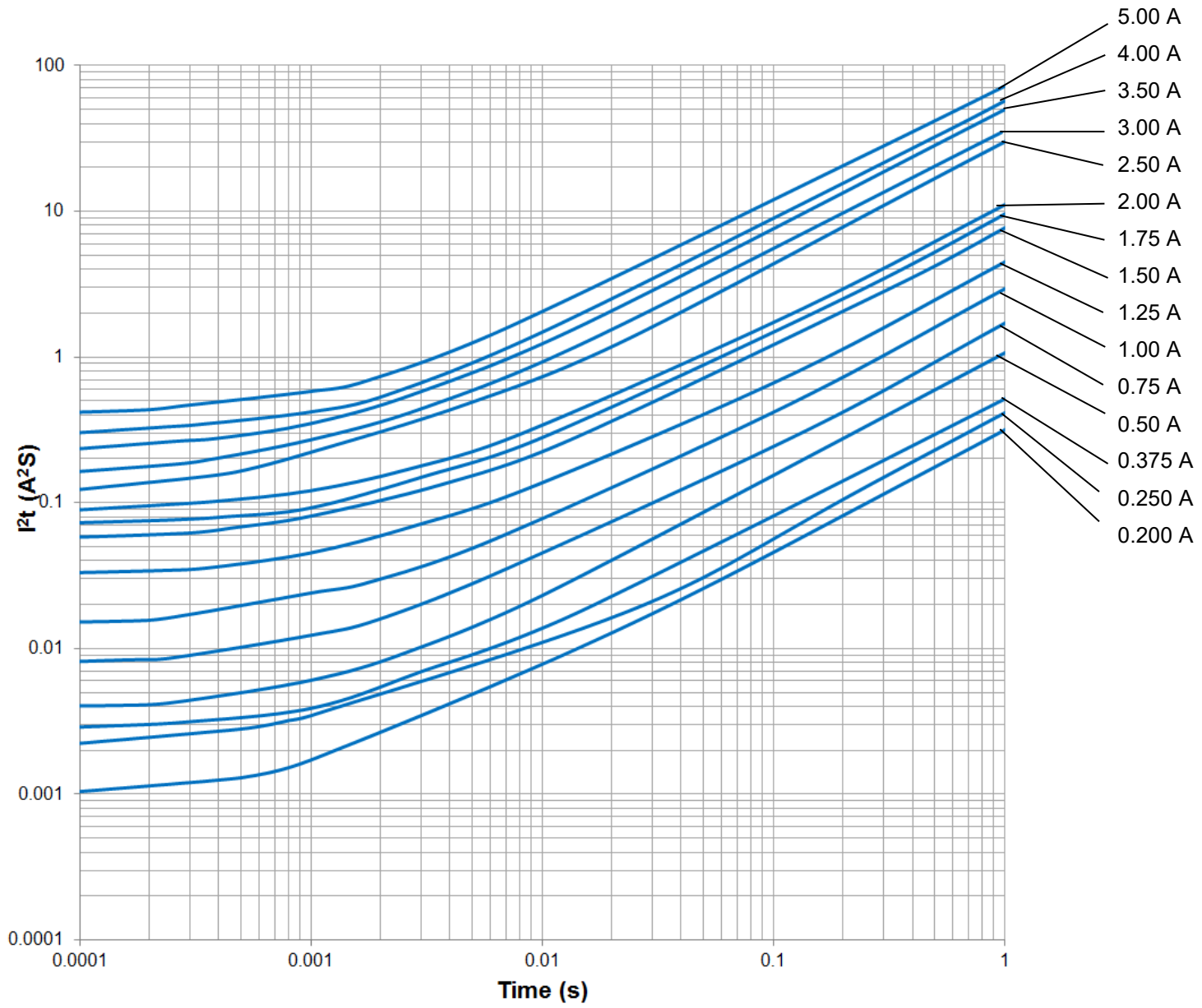

TF-FUSE® Thin Film Surface Mount Fuses

FF Series (Very Fast Acting), 0603 Size

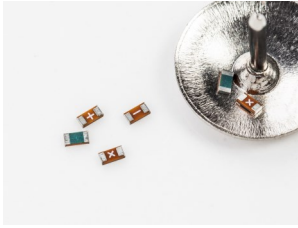

Features:

- Very fast acting at 200% overload current levels
- Low DCR
- High inrush current withstanding capability
- Fiberglass enforced epoxy fuse body
- Copper termination with nickel and tin plating
- Halogen free, RoHS compliance and lead-free

Shape and Dimensions:

Unit	Inch	mm
Length (L)	0.063 ± 0.004	1.60 ± 0.10
Width (W)	0.032 ± 0.004	0.81 ± 0.10
Thickness (T)	0.012 ± 0.004	0.30 ± 0.10
Termination bandwidth (b)	0.014 ± 0.004	0.36 ± 0.10

Clearing Time Characteristics:

% of Current Rating	Opening Time at 25°C
100%	4 hours min.
200%	5 seconds max.
300%	0.2 second max.

Applications:

- Panel
- Note book
- Toy
- HDD
- Finger Print
- Smart lock
- Battery Pack
- IoT

Agency Approval:

Recognized Under the Components Program of UL.
 File Number: E232989.

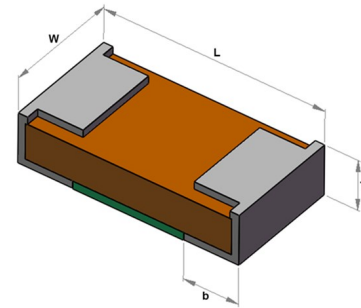

Typical Ratings and Characteristics:

Operating temperature: -55 to +90°C

Part Number	Current Rating (A)	Voltage Rating (Vdc)	Interrupting Rating	Nominal Cold DCR (Ω) ¹	Nominal I^2t (A ² s) ²	Marking
T0603FF0150TM	0.15	65	50A@35Vdc/ac 13A@65Vdc	2.2	0.0006	⊙
T0603FF0200TM	0.2	65		⊙⊙		
T0603FF0250TM	0.25	65		⊙⊙⊙		
T0603FF0375TM	0.375	65		⊙⊙⊙⊙		
T0603FF0500TM	0.5	65		⊙⊙⊙⊙⊙		
T0603FF0750TM	0.75	65		⊙⊙⊙⊙⊙⊙		
T0603FF1000TM	1	65		⊙⊙⊙⊙⊙⊙⊙		
T0603FF1250TM	1.25	65	35A@35V dc/ac 13A@65Vdc	0.048	0.052	⊙×
T0603FF1500TM	1.5	65		⊙⊙		
T0603FF1750TM	1.75	35	35A@35Vdc/ac 50A@24Vdc/ac	0.031	0.1	⊙⊙⊙
T0603FF2000TM	2	35		⊙⊙⊙⊙		
T0603FF2500TM	2.5	35		⊙⊙⊙⊙⊙		
T0603FF3000TM	3	35		⊙⊙⊙⊙⊙⊙		
T0603FF3500TM	3.5	35		⊙⊙⊙⊙⊙⊙⊙		
T0603FF4000TM	4	35		⊙⊙⊙⊙⊙⊙⊙⊙		
T0603FF5000TM	5	35		⊙⊙⊙⊙⊙⊙⊙⊙⊙		
					0.0095	1.1

¹ Measured at ≤ 10% of rated current and 25°C ambient . ² Melting I^2t at 0.001 sec.

TF-FUSE® Thin Film Surface Mount Fuses
FF Series (Very Fast Acting), 0603 Size

Average Pre-arcing Time Curves:

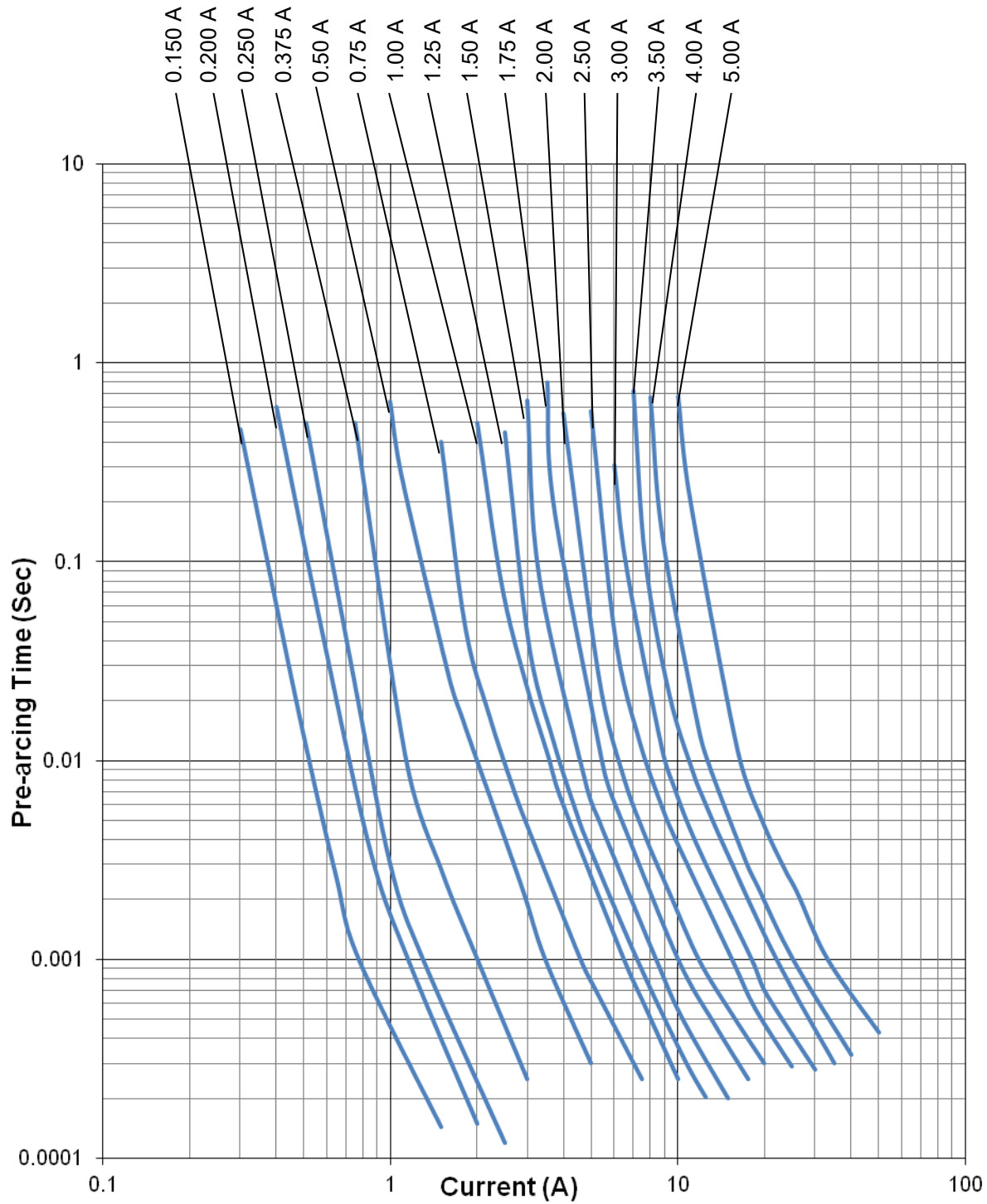

TF-FUSE® Thin Film Surface Mount Fuses
FF Series (Very Fast Acting), 0603 Size

Average I^2t vs. t Curves:

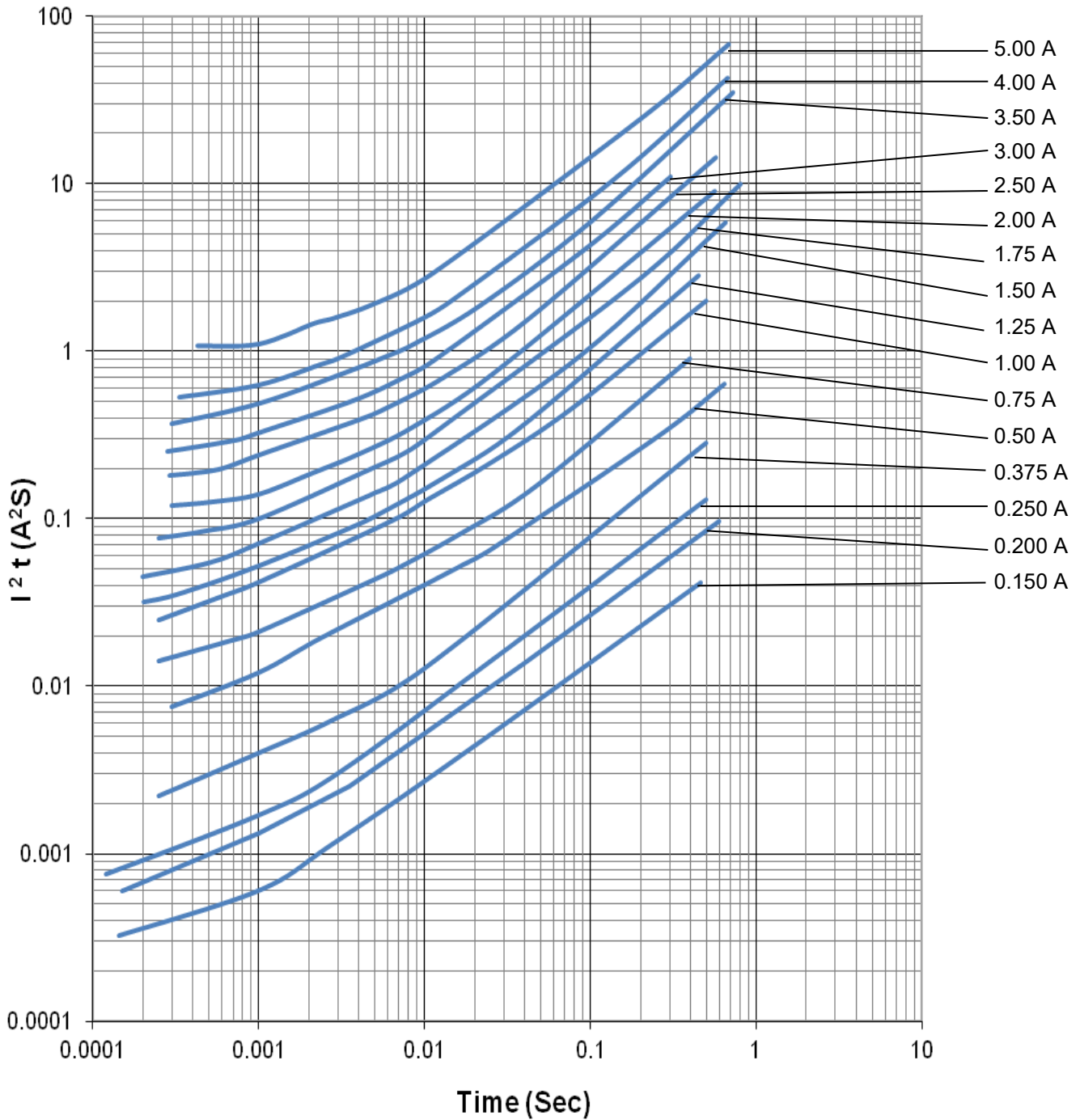

TF-FUSE® Thin Film Surface Mount Fuses

HI Series (High Inrush), 0603 Size



Features:

- Low DCR
- High inrush current withstanding capability
- Fiberglass enforced epoxy fuse body
- Copper termination with nickel and tin plating
- Halogen free, RoHS compliance and lead-free

Clearing Time Characteristics:

% of Current Rating	Opening Time at 25°C	
	100%	4 hours min.
200%	1 second min.	60 seconds max.
1000%	0.0002 second min.	0.02 second max.

Shape and Dimensions:

Unit	Inch	mm
Length (L)	0.063 ± 0.004	1.60 ± 0.10
Width (W)	0.032 ± 0.004	0.81 ± 0.10
Thickness (T)	0.014 ± 0.004	0.36 ± 0.10
Termination bandwidth (b)	0.014 ± 0.004	0.36 ± 0.10

Applications:

- Power tools
- DC-DC convert
- Panel
- PC
- Server
- Battery pack
- Set top box

Agency Approval:

Recognized Under the Components Program of UL.
 File Number: E232989.

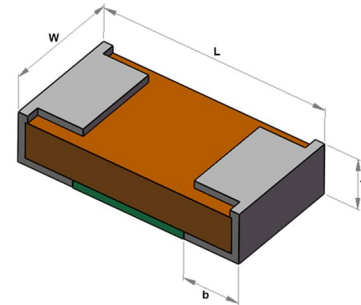

Typical Ratings and Characteristics:

Operating temperature: -55 to +90°C

Part Number	Current Rating (A)	Voltage Rating (Vdc)	Interrupting Rating	Nominal Cold DCR (Ω) ¹	Nominal I ² t (A ² s) ²	Marking
T0603HI0500TM	0.50	65	50A@35Vdc/ac 13A@65Vdc	0.1550	0.019	C
T0603HI0750TM	0.75	65		0.0830	0.036	D
T0603HI1000TM	1.00	65		0.0500	0.052	E
T0603HI1500TM	1.50	65		0.0290	0.110	T
T0603HI2000TM	2.00	35	35A@35Vdc/ac 50A@24Vdc/ac	0.0200	0.310	F
T0603HI2500TM	2.50	35		0.0165	0.400	J
T0603HI3000TM	3.00	35		0.0140	0.600	L
T0603HI3500TM	3.50	35		0.0120	0.800	N
T0603HI4000TM	4.00	35		0.0095	1.200	P

¹ Measured at ≤ 10% of rated current and 25°C ambient.

² Melting I²t at 0.001 sec.

TF-FUSE® Thin Film Surface Mount Fuses
HI Series (High Inrush), 0603 Size

Average Pre-arcing Time Curves:

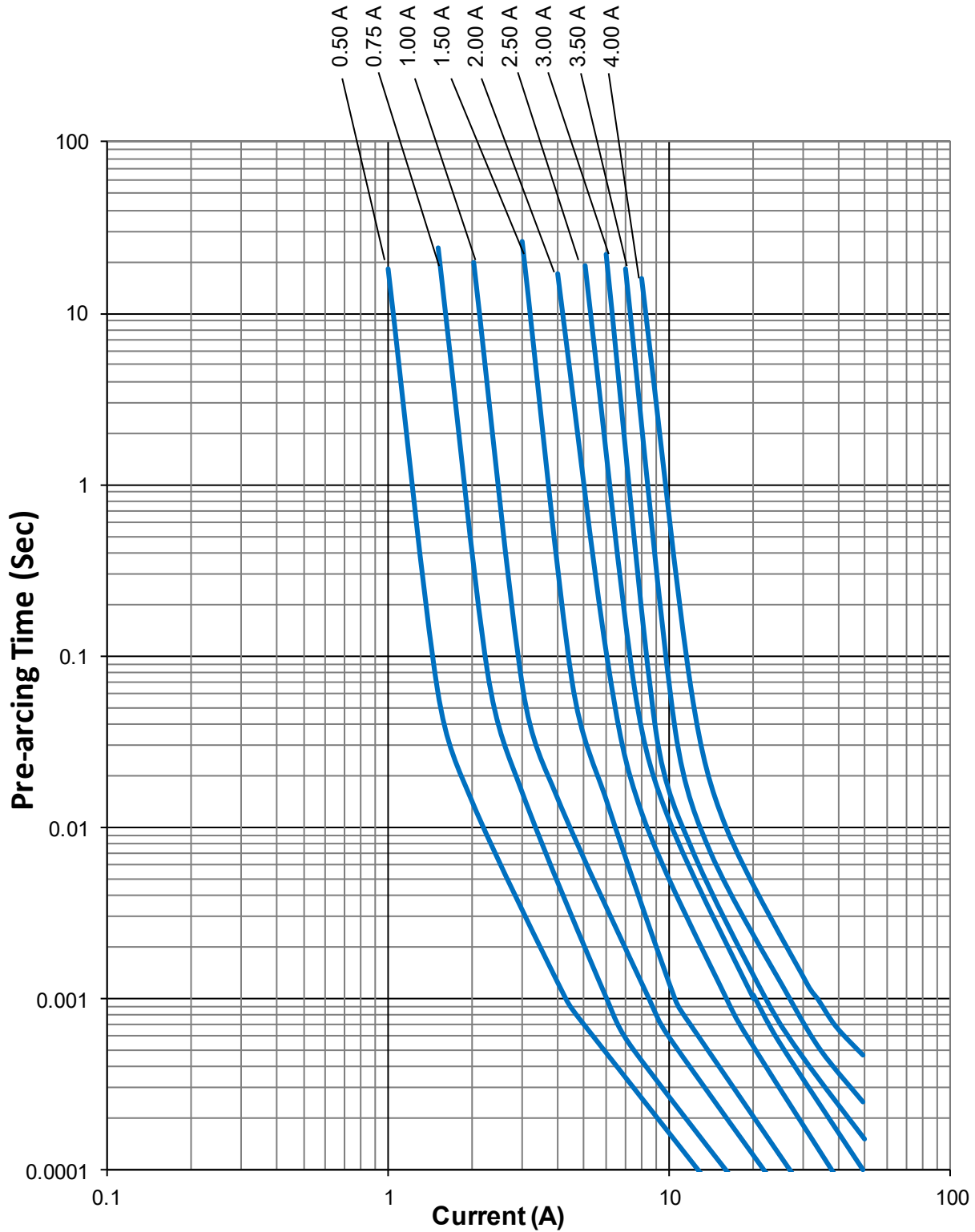

TF-FUSE® Thin Film Surface Mount Fuses
HI Series (High Inrush), 0603 Size

Average I^2t vs. t Curves:

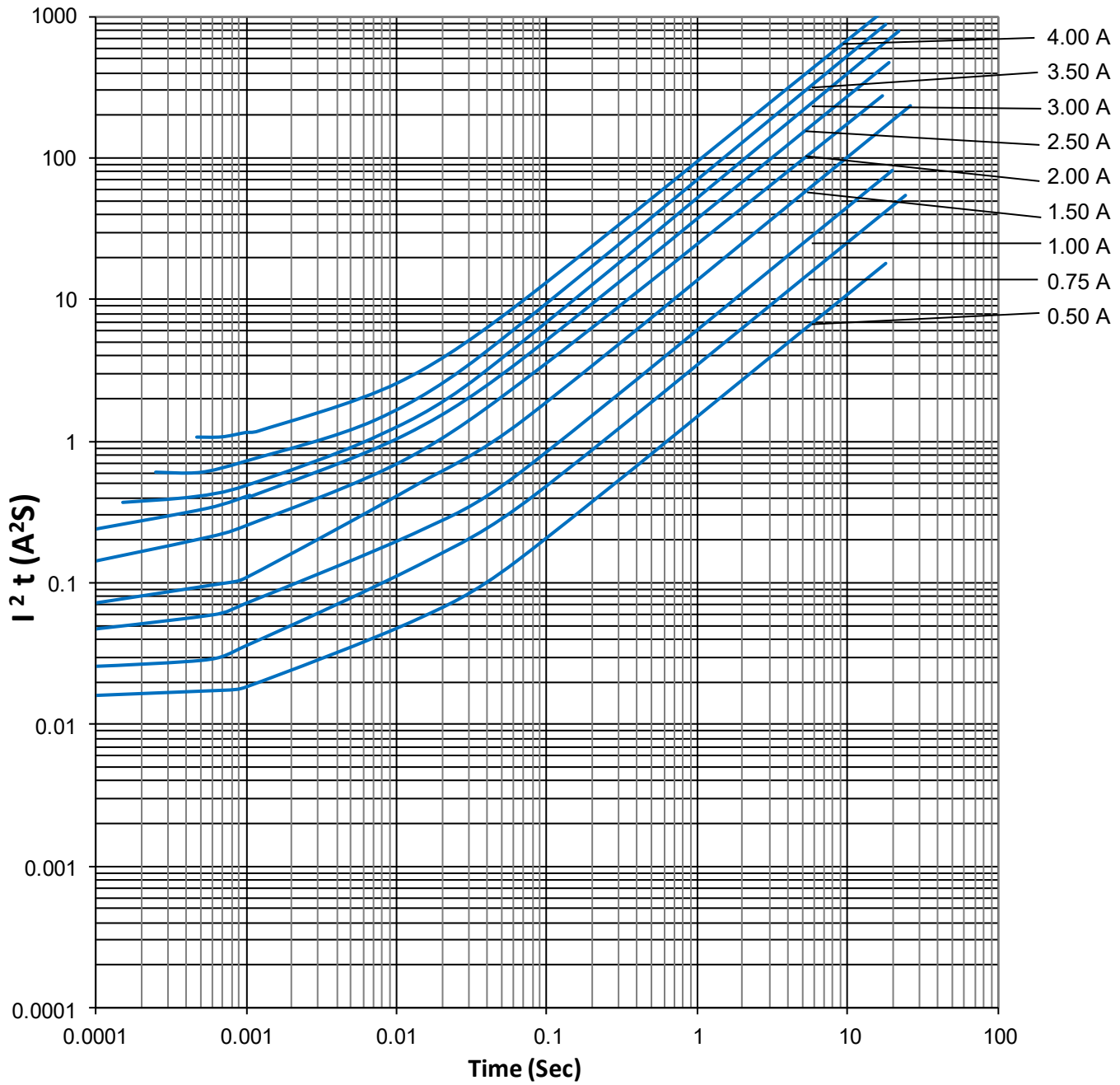

AirMatrix® Surface Mount Fuses

Product Identification:

AF 1206 F 2.00 T M

(1) (2) (3) (4) (5) (6)

- (1) **Series Code:** AF—AF Series
- (2) **Size Code:** Standard EIA Chip Sizes
- (3) **Time/Current Characteristic:** F
- (4) **Current Rating:** 2.00—2.00A
- (5) **Package Code:** T - Tape & Reel, B - Bulk
- (6) **Marking Code:** M - With Marking

AF2 1.00 V125 T M -7

(1) (2) (3) (4) (5) (6)

- (1) **Series Code:** AF2
- (2) **Current Rating Code:** 1.00—1.00A
- (3) **Voltage Rating Code:** V125—125VDC
- (4) **Package Code:** T - Tape & Reel, B - Bulk
No suffix after M: - 2K Tape & Reel
With suffix -7 after M: - 7K Tape & Reel
- (5) **Marking Code:** M - With Marking

MF 2410 F 0.500 T M -7

(1) (2) (3) (4) (5) (6) (5)

- (1) **Series Code:** MF—MF Series
- (2) **Size Code:** Standard EIA Chip Sizes
- (3) **Time/Current Characteristic:** F
- (4) **Current Rating:** 0.500—0.5A
- (5) **Package Code:** T - Tape & Reel, B - Bulk
No suffix after M: - 2K Tape & Reel
With suffix -7 after M: - 7K Tape & Reel
- (6) **Marketing Code:** M-With Marking

Recommended Land Pattern:

	AF1206		AF2		MF2410	
	Inch	mm	Inch	mm	Inch	mm
L	0.173	4.40	0.338	8.60	0.338	8.60
G	0.059	1.50	0.118	3.00	0.118	3.00
H	0.071	1.80	0.124	3.15	0.110	2.80

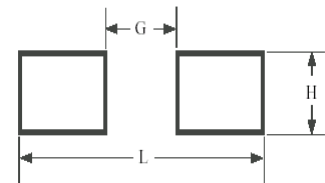

Packaging:

Chip Size	Parts on 7 inch (178 mm) Reel	Parts on 13 inch (330 mm) Reel
2410 (6125)	2,000	7,000
1206 (3216)	3,500	-

Storage:

The maximum ambient temperature shall not exceed 35°C . Storage temperatures higher than 35°C could result in the deformation of packaging materials.

The maximum relative humidity recommended for storage is 75%. High humidity with high temperature can accelerate the oxidation of the solder plating on the termination and reduce the solderability of the components.

Sealed vacuum foil bags with desiccant should only be opened prior to use.

The products should not be stored in areas where harmful gases containing sulfur or chlorine are present.

AirMatrix® Surface Mount Fuses

Fuse Selection and Temperature De-rating Guideline:

The ambient temperature affects the current carrying capacity of fuses. When a fuse is operating at a temperature higher than 25°C, the fuse shall be “de-rated”.

To select a fuse from the catalog, the following rule may be followed:

Catalog Fuse Current Rating = Nominal Operating Current / 0.75 / % De-rating at the maximum operating temperature.

Example: At maximum operating temperature of 65°C, % De-rating is 90%. The nominal operating current is 4 A. The current rating for fuse selected from the catalog shall be:

$$4 / 0.75 / 90\% = 5.9 \text{ or } 6.3 \text{ A.}$$

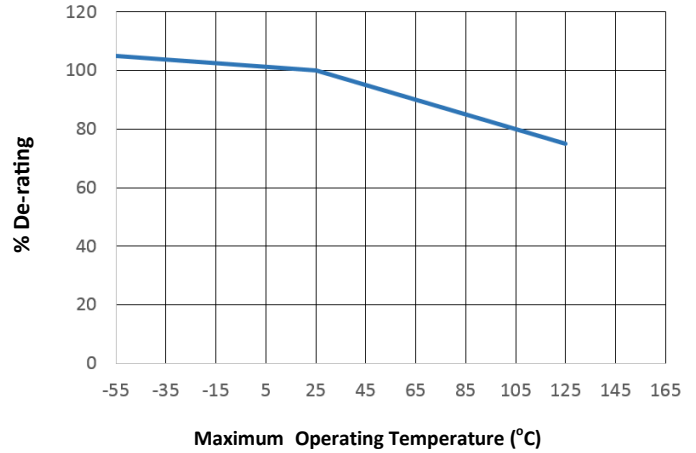

Environmental Tests:

No.	Reliability Test	Test Condition and Requirement	Test Reference
1	Bend	2 mm bend, DCR change within ±20% (±10% for ≤1A), no mechanical damage.	IEC60068-2-21
2	Solderability	245°C , 5 seconds, new solder coverage ≥95%	MIL-STD-202 Method 208
3	Soldering Heat Resistance	260°C, 10 seconds, 20% DCR change max. (10% for ≤ 1 A), new solder coverage 75% minimum	MIL-STD-202 Method 210
4	Life	80% rated current (75% for <1A), 2000 hours, ambient temperature (from +20°C to 30°C), voltage drop change within ±10%	Refer to AEM QIQ106
5	Thermal Shock	-65°C to +125°C, 100 cycles, DCR change ≤ ±10%, no mechanical damage	MIL-STD-202 Method 107
6	Mechanical Vibration	5 – 3000 Hz, 0.4 inch double amplitude or 30 G peak, DCR change ≤ ±10%, no mechanical damage	MIL-STD-202 Method 204
7	Mechanical Shock	1500 G, 0.5 milliseconds, half-sine shocks, DCR change ≤ ±10%, no mechanical damage	MIL-STD-202 Method 213
8	Salt Spray	5% salt solution, 48 hour exposure, DCR change ≤ ±10%, no excessive corrosion	MIL-STD-202 Method 101
9	Moisture Resistance	10 cycles, DCR change ≤ ±10%, no excessive corrosion	MIL-STD-202 Method 106

Moisture Sensitivity Level 1

AirMatrix® Surface Mount Fuses

Soldering Temperature Profile:

* Recommended Temperature Profile for Reflow Soldering

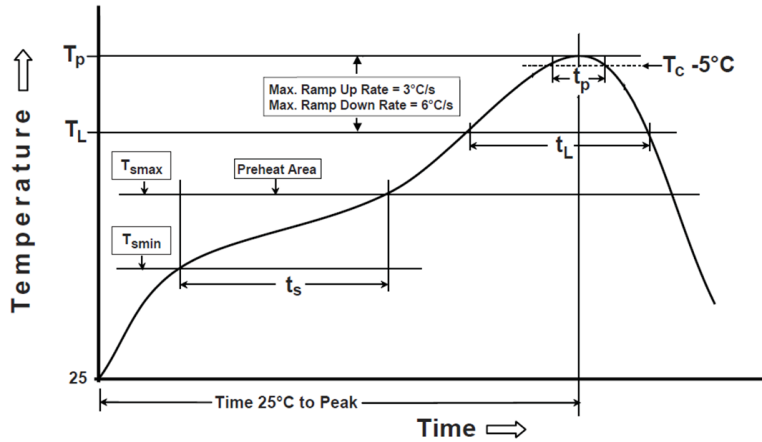

Profile Feature	Pb-Free Assembly
Preheat/Soak	
Temperature Min (T_{smin})	150°C
Temperature Max (T_{smax})	200°C
Time (t_s) from (T_{smin} to T_{smax})	60~120 seconds
Ramp-up rate (T_L to T_p)	3°C/second max.
Liquidous temperature (T_L)	217°C
Time (t_L) maintained above T_L	60~150 seconds
Peak package body temperature (T_p)	260°C
Time (t_p)* within 5°C of the specified classification temperature (T_c)	30 seconds *
Ramp-down rate (T_p to T_L)	6°C/second max.
Time 25°C to peak temperature	8 minutes max.
* Tolerance for peak profile temperature (T_p) is defined as a supplier minimum and a user maximum	

* Recommended Temperature Profile for Wave Soldering

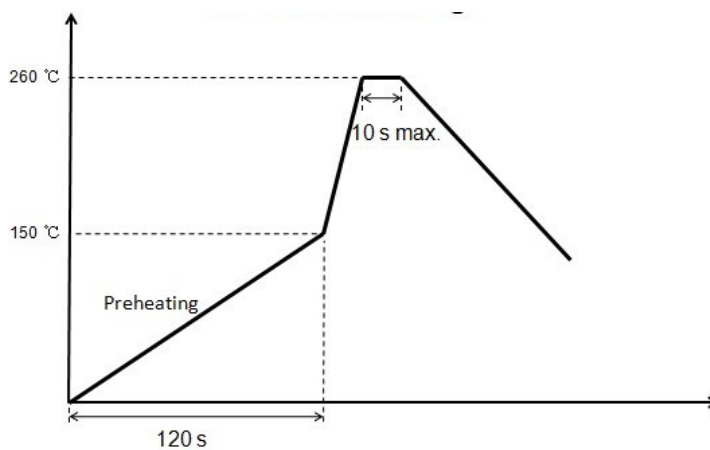

AirMatrix® Surface Mount Fuses

AF Series, 1206 Size



Features:

- Fast acting at 250% overload current level
- Excellent inrush current withstanding capability
- Extremely thin body for space saving
- Much safer with wire-in-air design
- Fiberglass enforced epoxy fuse body
- Copper termination with nickel and tin plating
- Operating temperature range: -55°C to +125 °C (with de-rating)
- 100% lead-free

Clearing Time Characteristics:

% of Current Rating	Clearing Time at 25°C	
	Min.	Max.
100%	4 hour	
250%		5 seconds

Shape and Dimensions:

Unit	Inch	mm
L	0.126 ± 0.008	3.20 ± 0.20
W	0.063 + 0.012 / -0.004	1.60 + 0.30 / -0.20
T	0.042 ± 0.006	1.08 ± 0.15
B	0.033 ± 0.012	0.85 ± 0.30

Application Fields:

- Notebook
- Backlight Driver
- DC/DC Converter
- Low voltage lighting power
- Automotive electronics
- Power adapter
- Panel
- Server
- Battery pack
- Medical Device

Agency Approval:

- Recognized Under the Components Program of Underwriters Laboratories. File Number: E232989
- TUV File Number: 50425087 (1.5-8A), 50425128 (10-15A)

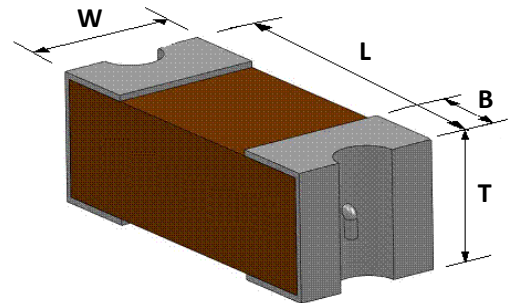

AirMatrix® Surface Mount Fuses

AF Series, 1206 Size

Ordering Information:

Part Number	Current Rating (A)	Marking (White)	Voltage Rating (Vdc)	Interrupting Rating	Nominal Cold DCR (Ω) ¹	Nominal I ² t (A ² s)	Agency Approval (TUV)
AF1206F1.50TM	1.50	G	65	50A@65Vdc	0.050	0.37	✓
AF1206F1.60TM	1.60	T			0.043	0.52	✓
AF1206F2.00TM	2.00	I			0.032	0.88	✓
AF1206F2.50TM	2.50	J			0.028	1.1	✓
AF1206F3.00TM	3.00	K			0.022	1.9	✓
AF1206F3.15TM	3.15	V			0.020	2.2	✓
AF1206F3.50TM	3.50	L			0.018	2.6	
AF1206F4.00TM	4.00	M			0.016	3.3	✓
AF1206F5.00TM	5.00	N	32	50A@32Vdc	0.013	5.4	✓
AF1206F6.30TM	6.30	O			0.010	8.9	✓
AF1206F7.00TM	7.00	P			0.0092	10.4	
AF1206F8.00TM	8.00	R			0.0084	13.5	✓
AF1206F10.0TM	10.0	Q			0.0050	11.2	✓
AF1206F12.0TM	12.0	X			0.0041	15.0	
AF1206F15.0TM	15.0	Y			0.0035	24.5	✓

1. Resistance is measured at $\leq 10\%$ of rated current and 25°C ambient.
2. Melting I²t is calculated at 0.001 second pre-arcing time.

AirMatrix® Surface Mount Fuses
AF Series, 1206 Size

Average Pre-arcing Time Curves:

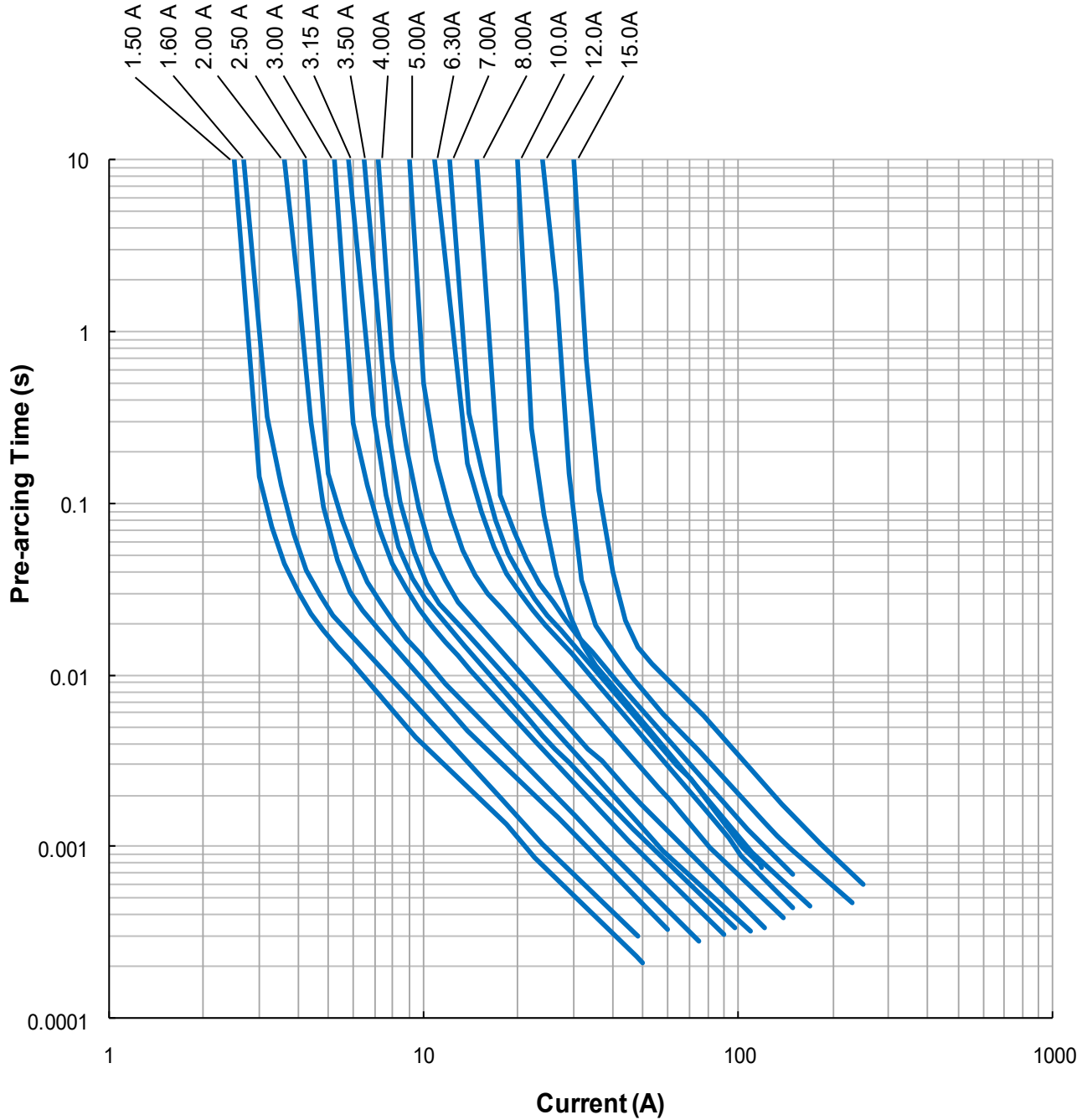

AirMatrix® Surface Mount Fuses
AF Series, 1206 Size

Average I^2t vs. t Curves:

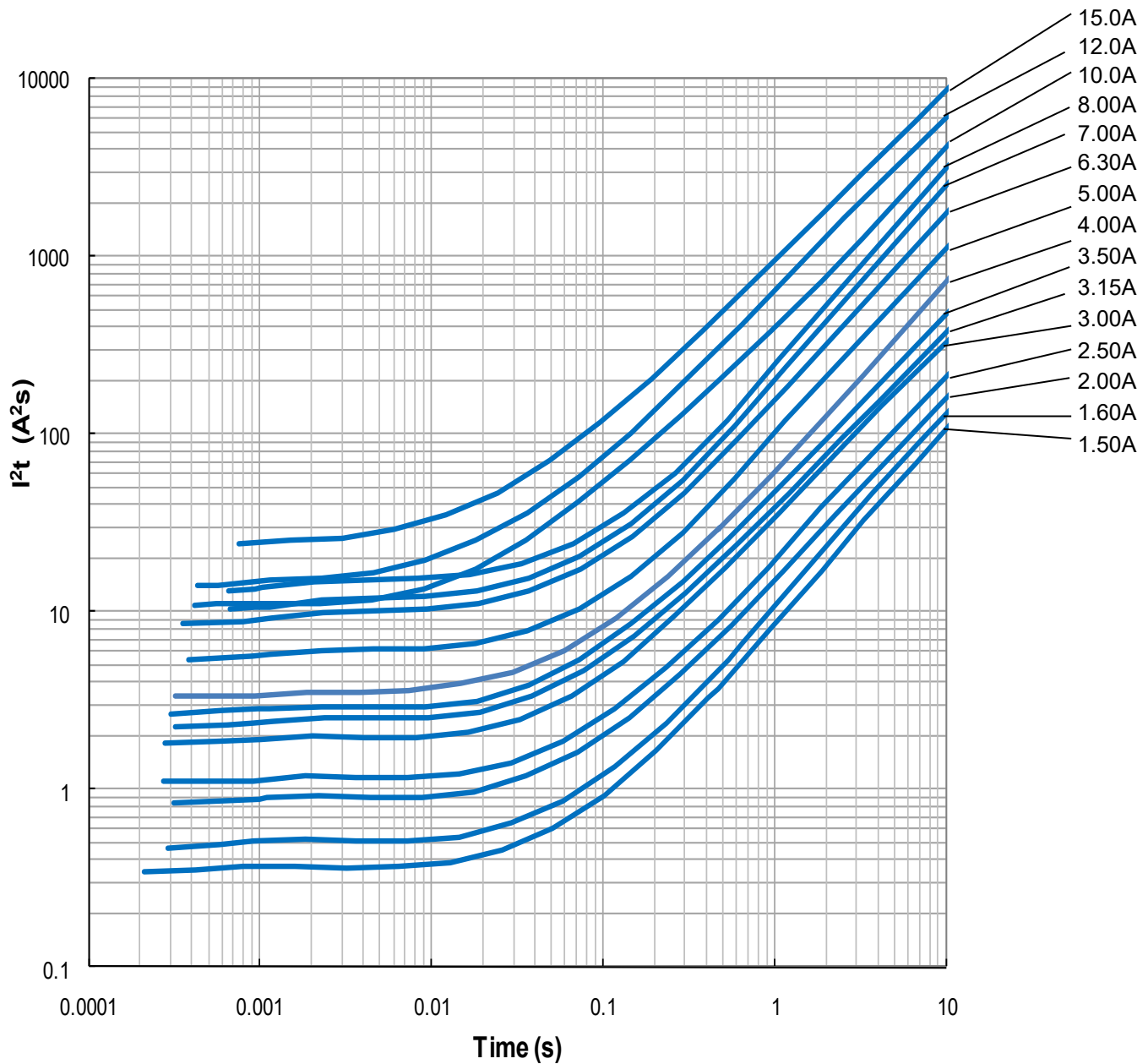

AirMatrix® Surface Mount Fuses

AF Series, 2410 Size



Features:

- Fast acting at 200% overload current level
- Excellent inrush current withstanding capability
- Fiberglass enforced epoxy fuse body
- Copper or copper alloy composite fuse link
- Copper termination with nickel and tin plating
- Halogen free, RoHS compliant and 100% lead-free
- Operating temperature range: -55°C to +125°C (with de-rating)

Clearing Time Characteristics:

% of Current Rating	Clearing Time at 25°C	
100%	4 hours min.	
200%(0.50~10.0 A)	0.01 seconds min.	5 seconds max.
200%(12.0~20.0 A)	0.01 seconds min.	20 seconds max.

Shape and Dimensions:

Unit	Inch	mm
L	0.240 ± 0.006	6.10 ± 0.15
W	0.098 ± 0.006	2.49 ± 0.15
T	0.085 ± 0.008	2.16 ± 0.20
B	0.053 ± 0.015	1.35 ± 0.38

Application Fields:

- Power Supply, e.g. DC/DC converters, DC/AC inverters, Backlight drivers
- Consumer Electronics, e.g. LCD TVs, PDP, DVDs, PCM
- Communication Technology, e.g. Telecom systems, Networking, Modems, Routers, Chargers, Base stations
- Office Automation Electronics
- IT Products, e.g. LCD monitors, Notebooks, PC servers
- Power Tool
- Medical device
- Lighting

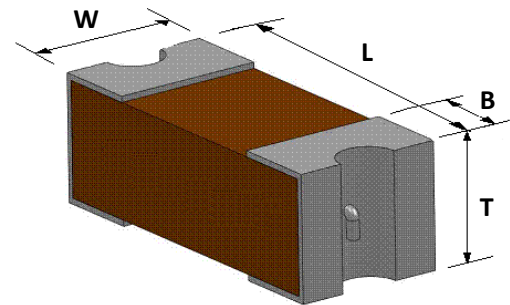

Agency Approval:

- Recognized Under the Components Program of Underwriters Laboratories. File Number: E232989
- PSE Certificate No: JD60132863 (1-2A), JD60136813 (2.5-15A)
- TUV File Number: 50209083 (0.5-2A), 50425086 (2.5-15A), 50425127 (20A)
- CQC No.: CQC11012065955

AirMatrix[®] Surface Mount Fuses

AF Series, 2410 Size

Ordering Information:

Part Number	Current Rating (A)	Voltage Rating (V)		Interrupting Rating	Nominal Cold DCR (Ω) ¹	Nominal I^2t (A ² s) ²	Agency Approval				Marking (Optional) ³			
		AC	DC				UL	PSE	TUV	CQC				
AF2-0.50V125TM	0.5	250		TUV: 0.5 ~ 2 A 100A @ 250VAC 50A @ 125VDC 2.5 ~ 10 A 50A @ 125VDC 15 ~ 20 A 50A @ 65VDC CQC: 0.5A, 1A, 2A 100A @ 250VAC 50A @ 125VDC	0.231	0.10	√		√	√	C			
AF2-0.63V125TM	0.63				0.174	0.16	√		√			S		
AF2-0.75V125TM	0.75				0.148	0.23	√					D		
AF2-1.00V125TM	1.0				0.093	0.59	√	√	√	√		E		
AF2-1.25V125TM	1.25				0.07	0.96	√	√	√			F		
AF2-1.50V125TM	1.5				0.062	1.19	√	√				G		
AF2-2.00V125TM	2.0				0.042	2.75	√	√	√	√		I		
AF2-2.50V125TM	2.5				0.031	1.21	√	√	√			J		
AF2-3.00V125TM	3.0				125		PSE: 1 ~ 2A 100A @ 250VAC 50A @ 125VDC 2.5 ~ 10A 50A @ 125VDC 15A 50A @ 65VDC UL: 0.5 ~ 2A 100A @ 250VAC 2.5 ~ 8A 50A @ 125VAC 10A 300A @ 32VDC 50A @ 125VDC 35A @ 125VAC 12 ~ 15A 300A @ 32VDC 50A @ 65VDC 50A @ 65VAC 20A 300A @ 32VDC 100A @ 65VDC 50A @ 65VAC	0.0249	1.73	√	√	√		K
AF2-3.15V125TM	3.15							0.0232	2.2	√	√	√		
AF2-3.50V125TM	3.5	0.022	2.5	√								L		
AF2-4.00V125TM	4.0	0.0172	4.1	√				√	√			M		
AF2-5.00V125TM	5.0	0.0143	5.9	√				√	√			N		
AF2-6.30V125TM	6.3	0.01	12.5	√				√	√			O		
AF2-7.00V125TM	7.0	0.0094	14.2	√								P		
AF2-8.00V125TM	8.0	0.0086	20.3	√				√	√			R		
AF2-10.0V125TM	10.0	0.0066	29.2	√				√	√			Q		
AF2-12.0V065TM	12.0	65	65	300A @ 32VDC 100A @ 65VDC 50A @ 65VAC				0.0053	49.2	√				X
AF2-15.0V065TM	15.0				0.0038	102.5	√	√	√			Y		
AF2-20.0V065TM	20.0				0.0034	126.2	√		√			Z		

1. Measured at ≤ 10% rated current and 25°C ambient.

2. Melting I^2t at 0.001 second pre-arcing time.

3. White Marking Character Code.

AirMatrix® Surface Mount Fuses
AF Series, 2410 Size

Average Pre-arcing Time Curves:

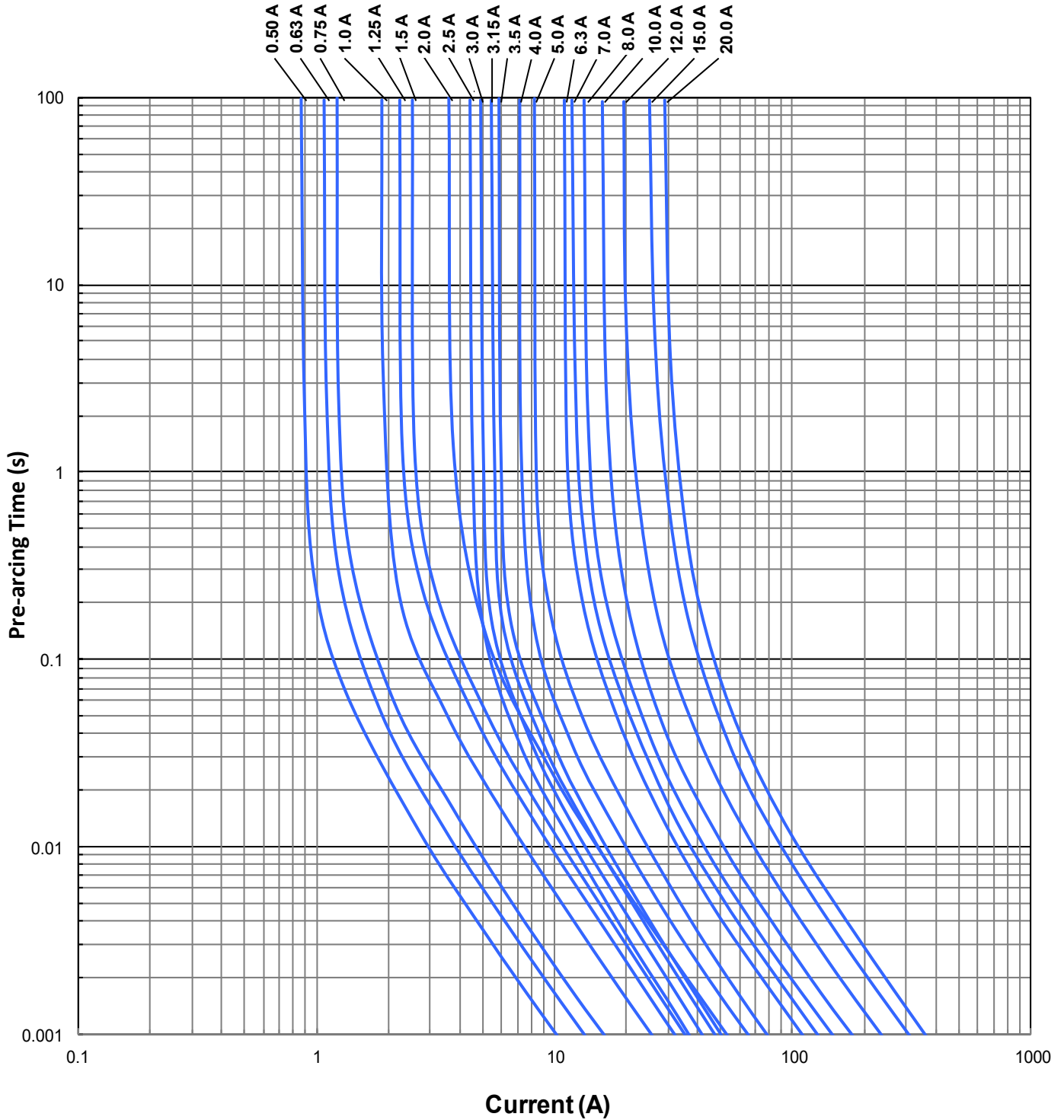

AirMatrix® Surface Mount Fuses
AF Series, 2410 Size

Average I^2t vs. t Curves:

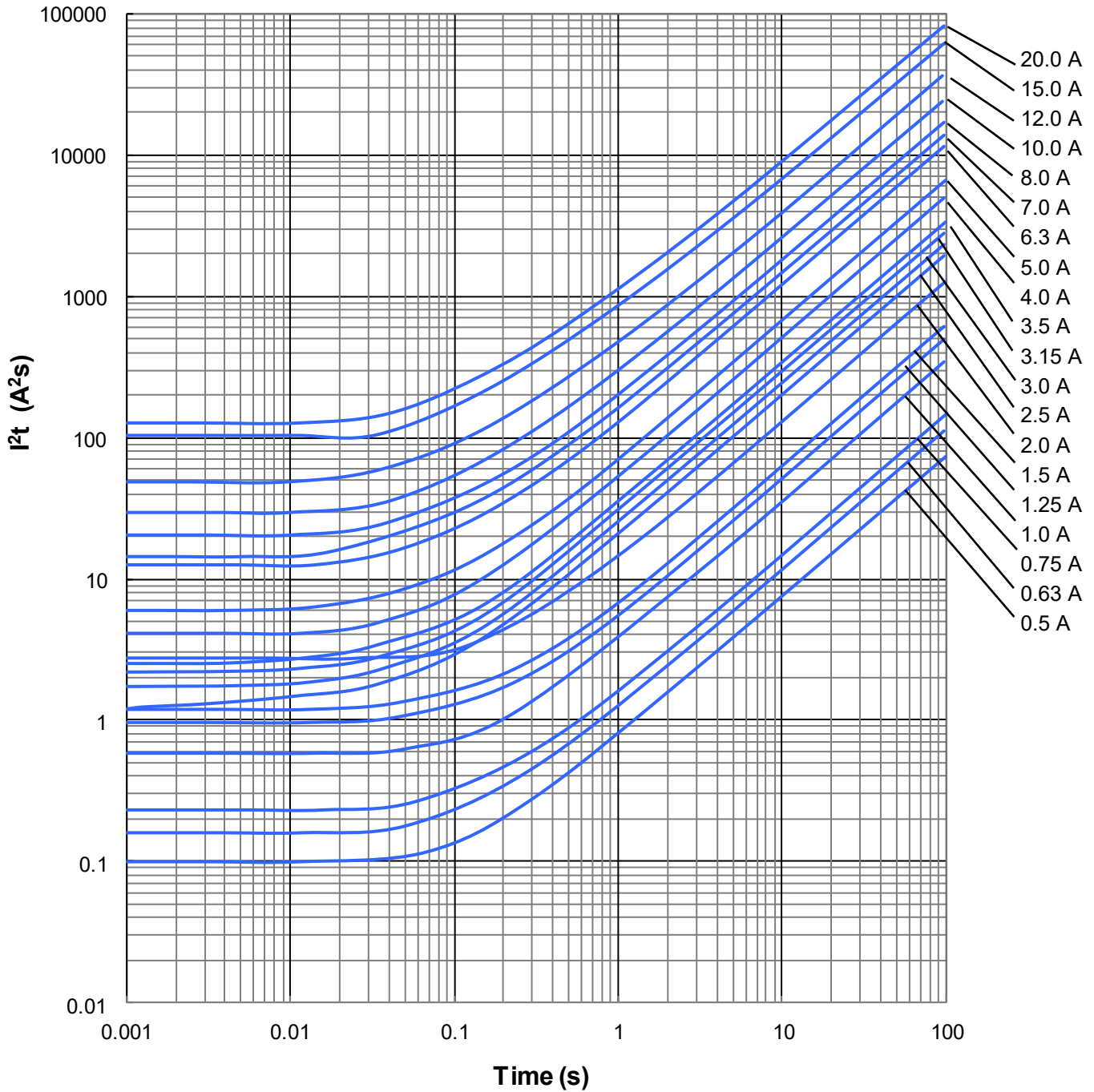

AirMatrix® Surface Mount Fuses

AF101 Series

Features:

- Excellent inrush current withstanding capability
- Fiberglass enforced epoxy fuse body
- Copper or copper alloy composite fuse link
- Copper termination with nickel and tin plating
- Halogen free, RoHS compliant and 100% lead-free

Application Fields:

- Server Systems
- Blade Servers
- UPS & Routers
- Fan
- E-bike
- Power tools
- BMS of Li-ion battery

Clearing Time Characteristics:

% of Current Rating	Clearing Time at 25°C	
	Min.	Max.
100%	4 hours min.	—
200%	—	60 seconds

Shape and Dimensions:

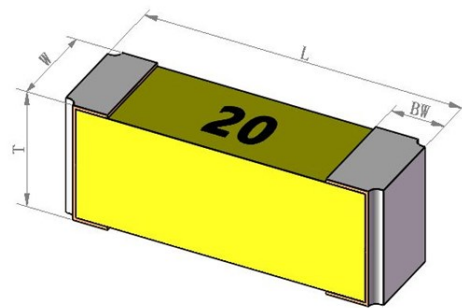

Product Identification:

AF 4012 H 20A0 T

(1) (2) (3) (4) (5)

(1) **Product type code:** AirMatrix fuse

(2) **Dimension code:** L x W (inch)

The first two digits - L (length)

The last two digits - W (width)

(3) **Characteristic code:** H - High inrush

(4) **Current rating code:** 20A0 - 20.0A

(5) **Package code:** T – Tape and Reel; B - Bulk

AF101: AF-Airmatrix Fuse 101-Series Code

Size	L	W	T	BW
4012	0.398 ± 0.012	0.129 ± 0.012	0.129 ± 0.012	0.061 ± 0.012
	(10.10 ± 0.30)	(3.30 ± 0.30)	(3.30 ± 0.30)	(1.55 ± 0.30)
4818	0.480 ± 0.012	0.175 ± 0.012	0.129 ± 0.012	0.061 ± 0.012
	(12.20 ± 0.30)	(4.50 ± 0.30)	(3.30 ± 0.30)	(1.55 ± 0.30)

Ordering Information:

Operating Temperature Range: -55°C to +125°C

AEM Part Number	Current Rating (A)	Max. Voltage Rating (V)	Interrupting Rating	Nominal Cold DCR (mΩ) ¹	Nominal I ² t (A ² s) ²
AF4012H20A0T	20	75	1000A@75VDC	2.24	240
AF4012H25A0T	25	75		1.68	350
AF4012H30A0T	30	75		1.35	570
AF4818H40A0T	40	75		1.26	1100
AF4818H50A0T	50	75		1.12	1370
AF4818H60A0T	60	75		0.83	1800

1. Measured at ≤10% of rated current and 25°C ambient.

2. Melting I²t at 1ms pre-arcing time

AirMatrix® Surface Mount Fuses

AF101 Series

Clearing Time vs. Current Curve :

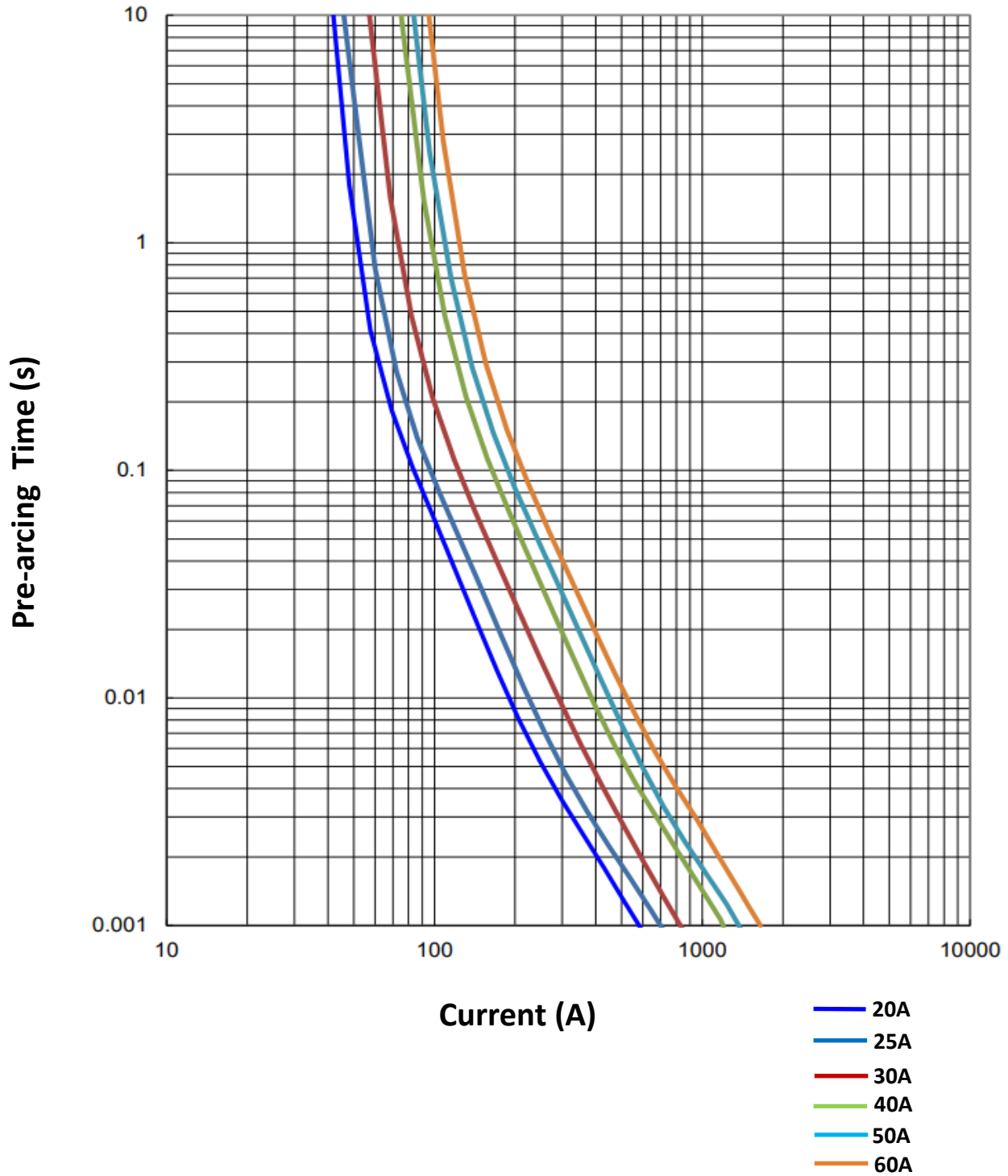

AirMatrix® Surface Mount Fuses

AF101 Series

I²t vs .t Curves:

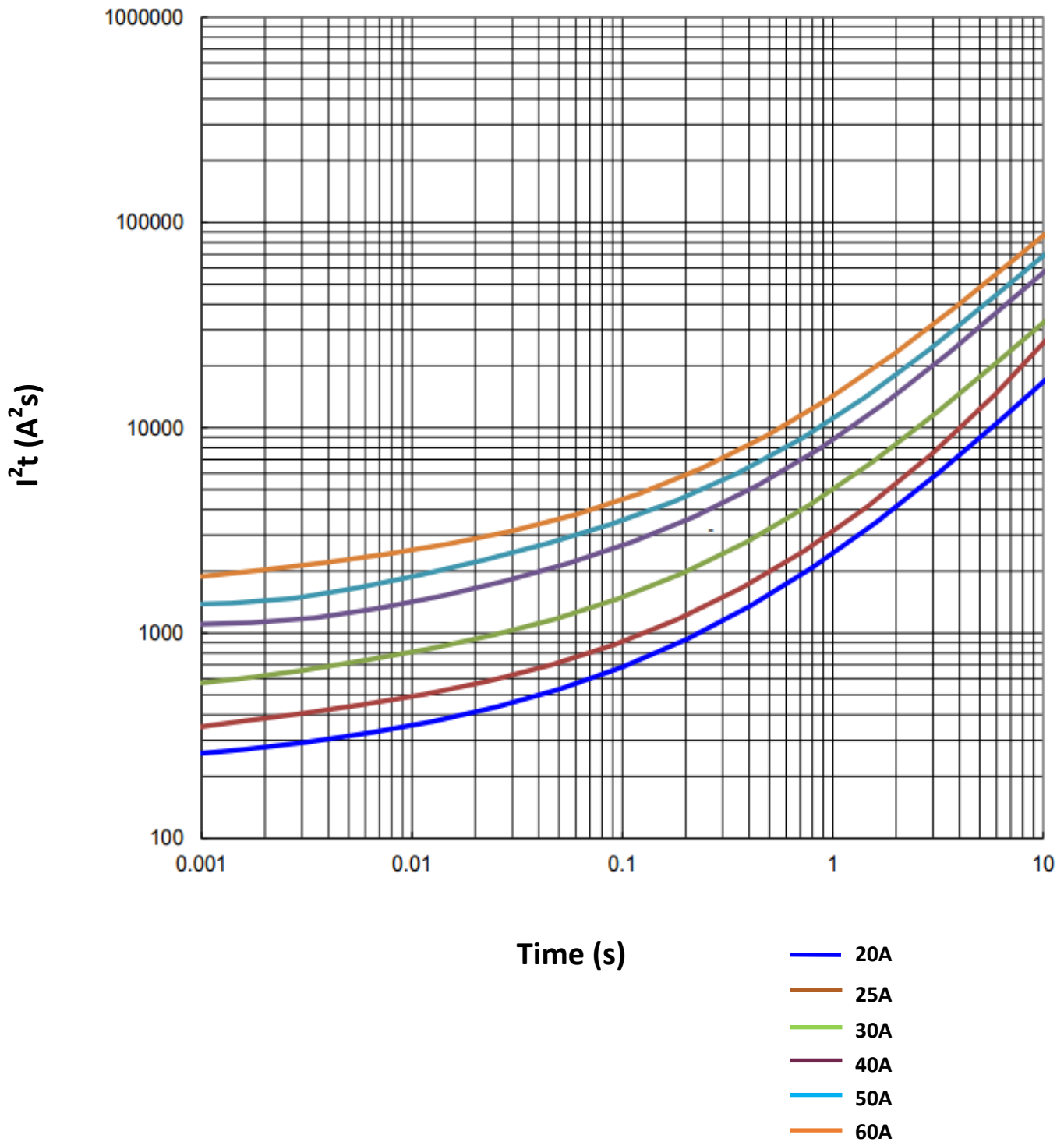

AirMatrix® Surface Mount Fuses

AF101 Series

Temperature De-rating Guideline:

The ambient temperature affects the current carrying capacity of fuses. When a fuse is operating at a temperature higher than 25°C, the fuse shall be “derated” according to the de-rating curve.

Special Measuring Equipment:

1. Clear Time: Clear time is measured with clear time tester.
2. DC Resistance: DC resistance is measured with HIOKI RM3545.
3. Interrupting Capability: Interrupting capability is measured with short circuit tester.

Packaging:

Chip Size	Parts on 13 inch (330 mm) Reel
4012	2,000
4818	2,000

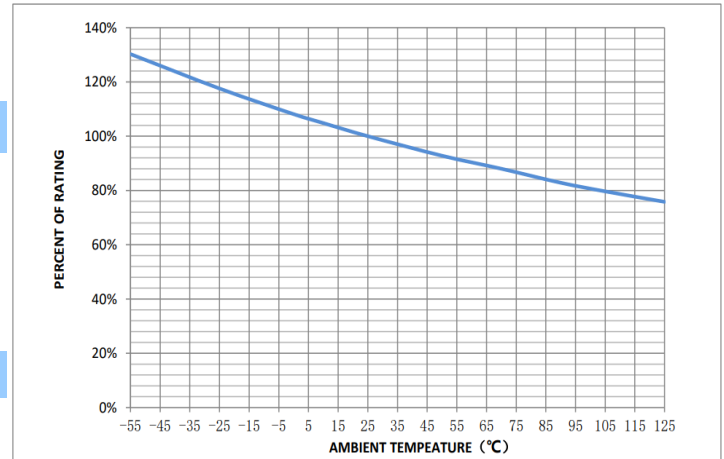

Recommended PC Board Land Pattern:

Chip Size	4012	4818
L	0.496	0.63
INCH (mm)	(12.6)	(16.0)
G	0.225	0.225
INCH (mm)	(5.72)	(5.72)
H	0.135	0.213
INCH (mm)	(3.43)	(5.40)

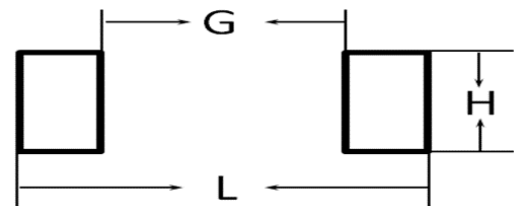

Reliability Tests:

Reliability Test	Test Condition and Requirement
Reflow & Bend	3 reflows at 245°C followed by a 2 mm bend, ±20% DCR change max. (10% for ≤1A), no mechanical damage
Solderability	245°C, 5 seconds, new solder coverage ≥90%
Soldering Heat Resistance	260°C, 10 seconds, ±20% DCR change max. (10% for ≤ 1 A), new solder coverage 75% minimum
Life	25°C, 2000 hours, 80% rated current (75% for <1A), voltage drop changes ≤±20%
Thermal Shock	-65°C to +125°C, 100 cycles, ±20% DCR change max., no mechanical damage
Mechanical Vibration	5–3000 Hz, 0.4 inch double amplitude or 30 G peak, ±20% DCR change max., no mechanical damage
Mechanical Shock	1500 G, 0.5 milliseconds, half-sine shocks, ±20% DCR change max., no mechanical damage
Salt Spray	5% salt solution, 48 hour exposure, ±20% DCR change max., no excessive corrosion
Moisture Resistance	10 cycles, ±20% DCR change max., no excessive corrosion

AirMatrix® Surface Mount Fuses

AF101 Series

Recommended Temperature Profile for Reflow Soldering:

Profile Feature	Pb-Free Assembly
Preheat/Soak	
Temperature Min (T_{smin})	150°C
Temperature Max (T_{smax})	200°C
	60-120 seconds
Ramp-up rate (T_L to T_p)	3°C/ second max.
Liquidous temperature (T_L)	217°C
Time (t_L) maintained above T_L	60-150 seconds
Peak package body temperature (T_p)	260°C
Time (t_p)*within 5°C of the specified classification temperature (T_c)	30* seconds
Ramp-down rate (T_p to T_L)	6°C/ second max
Time 25°C to peak temperature	8 minutes max

*Tolerance for peak profile temperature (T_p) is defined as a supplier minimum and auser maximum.

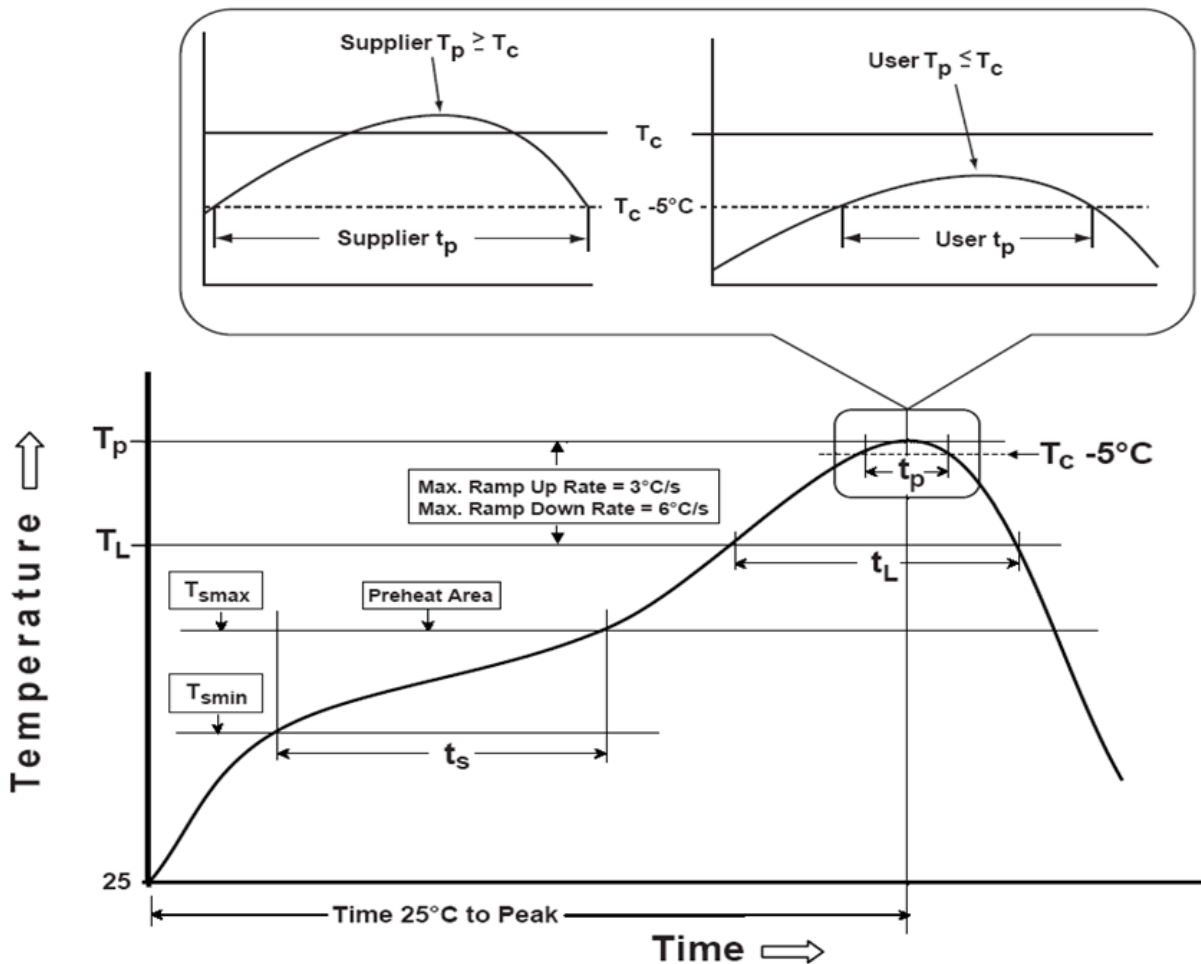

Recommended conditions for hand soldering:

1. Appropriate temperature (max.) of soldering iron tip/soldering time (max.): 280°C / 10 s or 350°C / 3 s
2. Using hot air rework station with tip that can melt the solder on both terminations at the same time is strongly recommended. Do not directly contact the chip termination with the tip of soldering iron.

AirMatrix[®] Surface Mount Fuses

MF Series, 2410 Size



Features:

- Extremely small size with 250 VAC rating
- Surface mount fuses in AC applications
- Excellent inrush current withstanding capability
- Fiberglass enforced epoxy fuse body
- Copper termination with nickel and tin plating
- 100% lead-free
- Operating temperature range: -55°C to +125 °C (with de-rating)
- Compliant with IEC 60127-4

Clearing Time Characteristics:

% of Current Rating	Clearing Time at 25°C	
	Min.	Max.
125%	1 hour	
200%		120 seconds
1000%	0.001 seconds	0.01 seconds

Shape and Dimensions:

	Inch	mm
L	0.240 ± 0.006	6.10 ± 0.15
W	0.098 ± 0.006	2.49 ± 0.15
H	0.085 ± 0.008	2.16 ± 0.20
BW	0.053 ± 0.015	1.35 ± 0.38
P	≥ 0.118	≥ 3.00

Application Fields:

- Power tools
- DC-DC convert
- Power adapter
- Panel
- Server
- Battery pack
- Medical
- Lighting
- Industrial Equipment
- White Goods

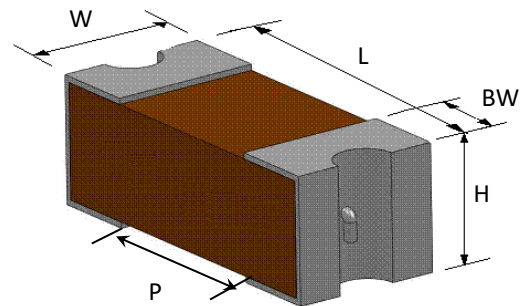

Agency Approval:

Agency	File No.
UL	E232989
CQC	CQC11012065956
KC	SU05038-12001/12002
PSE	JD 60130890
VDE	40034853

AirMatrix[®] Surface Mount Fuses

MF Series, 2410 Size

Ordering Information:

Part Number	Current Rating (A)	Voltage Rating (Vac)	Interrupting Ratings	Nominal Cold DCR (Ω) ¹	Voltage Drop Max. (mV) ²	Nominal I^2t (A^2s) ³	Marking (Black)
MF2410F0.500TM	0.50	250	100A @ 250Vac	0.206	166	0.11	C
MF2410F0.630TM	0.63	250		0.148	144	0.20	S
MF2410F0.800TM	0.80	250		0.109	139	0.35	H
MF2410F1.000TM	1.00	250		0.084	129	0.62	E
MF2410F1.250TM	1.25	250		0.065	128	1.00	F
MF2410F1.600TM	1.60	250		0.049	127	1.80	T
MF2410F2.000TM	2.00	250		0.038	123	3.00	I

Notes:

1. Resistance is measured at $\leq 10\%$ of rated current and 25°C ambient.
2. Voltage drop is measured at 100% of rated current.
3. Melting I^2t is calculated at 0.001 second pre-arcing time.

AirMatrix® Surface Mount Fuses
MF Series, 2410 Size

Average Pre-arcing Time Curves:

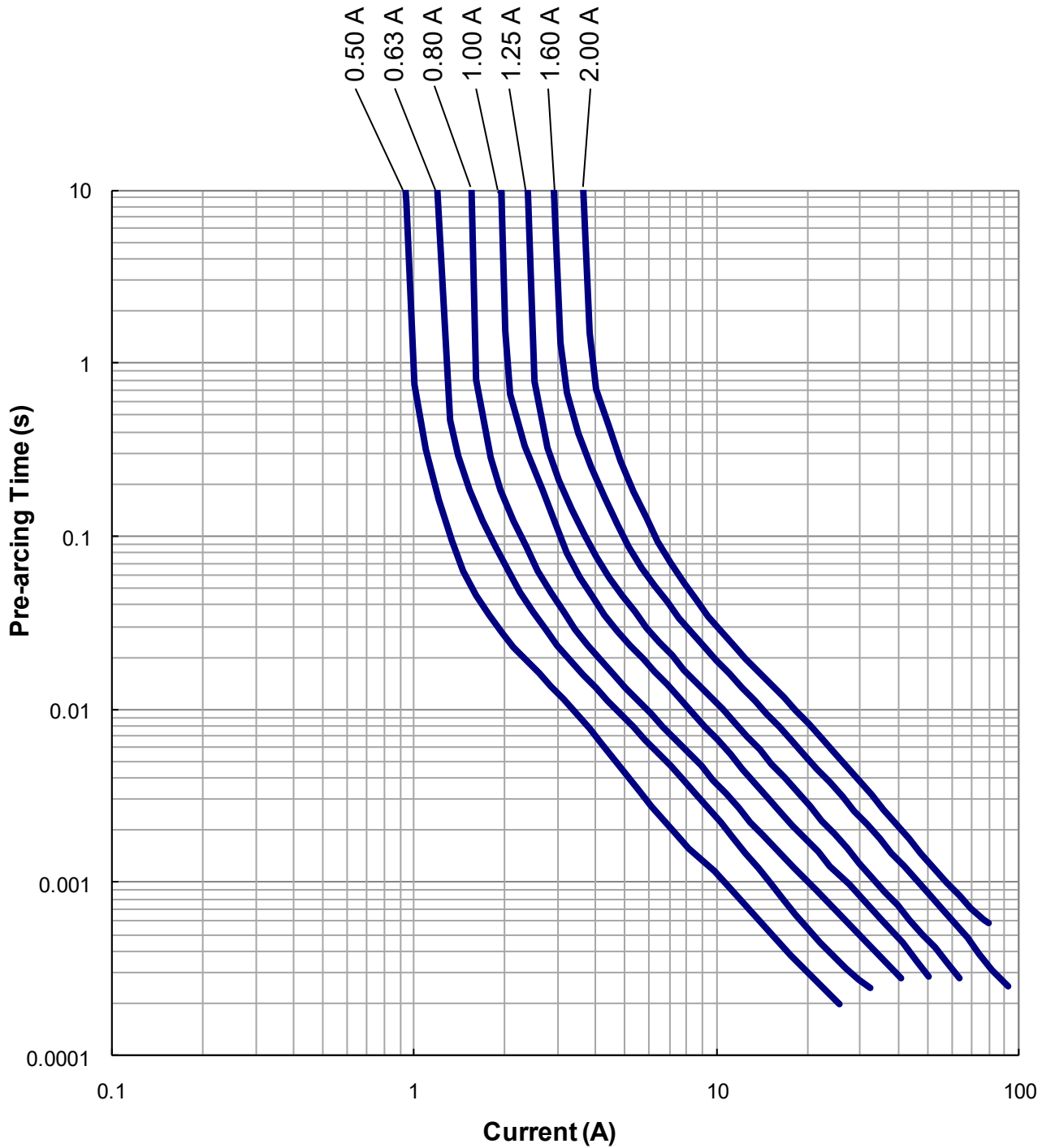

AirMatrix® Surface Mount Fuses
MF Series, 2410 Size

Average I^2t vs. t Curves:

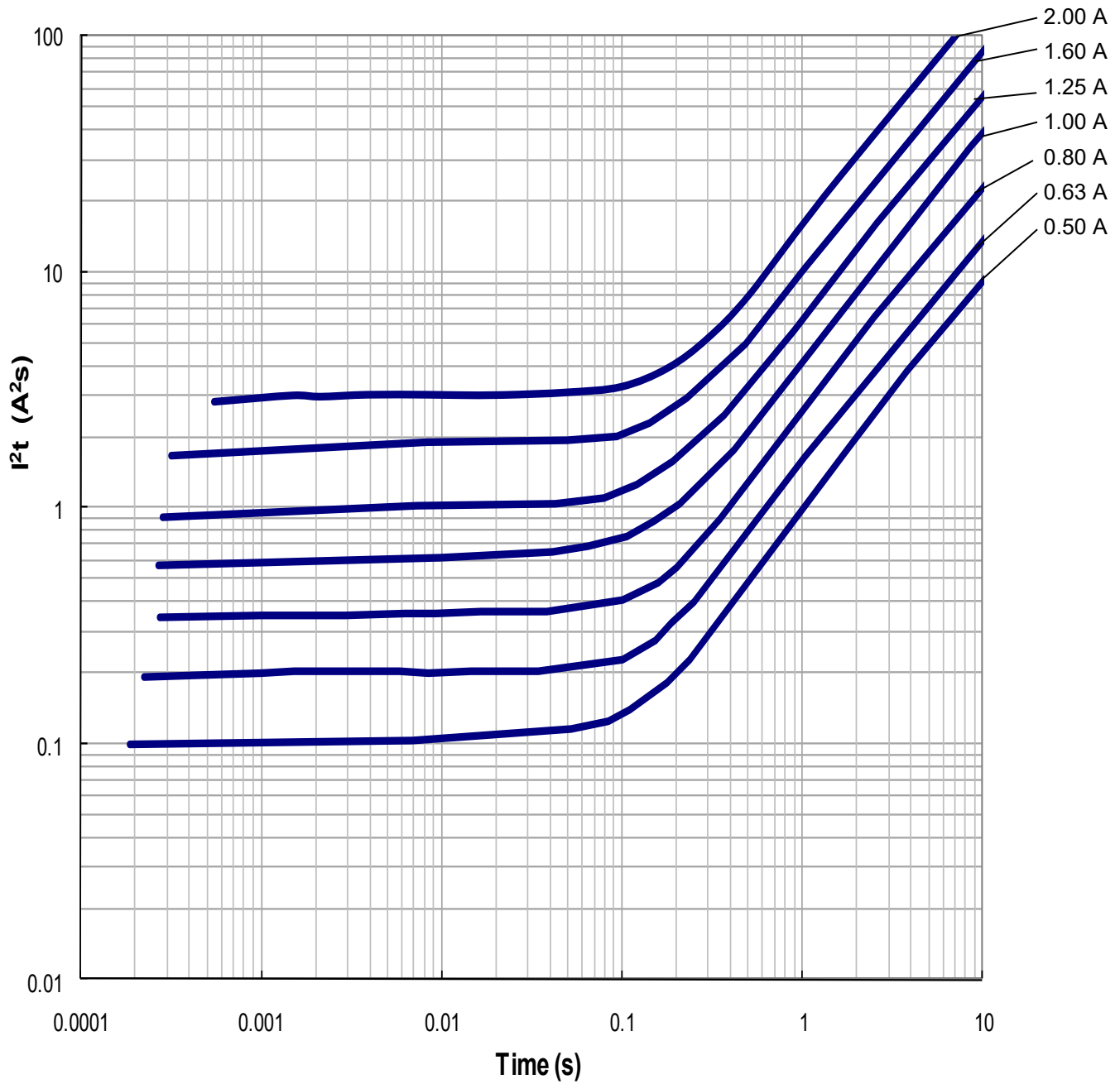

High Power Surface Mount Fuse

CM2822H Series

Product Identification:

CM 2822 H 20A0 T

(1) (2) (3) (4) (5)

- (1) **Product Code:** CM-Commercial Molding Fuse
 - (2) **Size code: L x W (inch):** the first two digits - L (length), the last two digits - W (width)
 - (3) **Series code:** H
 - (4) **Current rating code:** e.g. 20A0: 20.0A
 - (5) **Package code:** T - Tape & Reel, B - Bulk
- Marking:** Top Line:  AEM Logo; **CMH:** CM2822H Series
 Bottom Line: Current Rating Code

Recommended Land Pattern:

Chip Size	2822 (7358)
L Inch (mm)	0.386 (9.8)
G Inch (mm)	0.173 (4.4)
H Inch (mm)	0.228 (5.8)

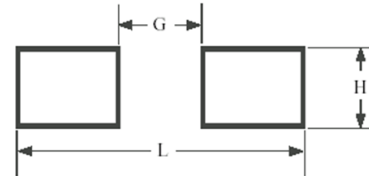

Reliability Tests:

No.	Reliability Test	Test Condition and Requirement	Referenced International Standard
1	Bend	2 mm bend, DCR change within $\pm 20\%$, no mechanical damage	IEC60068-2-21
2	Solderability	245°C for 5 seconds, new solder coverage $\geq 95\%$	MIL-STD-202 Method 208
3	Soldering Heat Resistance	260°C, 10 seconds, DCR change within $\pm 20\%$, new solder coverage 75% minimum, no mechanical damage	MIL-STD-202 Method 210
4	Terminal Strength	Gradually apply 1.8 kg force to the bottom of the part for 60 seconds, DCR change within $\pm 20\%$, no mechanical damage	AEC Q200-006
5	Life	80% rated current, 2000 hours, ambient temperature from +20°C to 30°C, voltage drop change within $\pm 20\%$	MIL-STD-202 Method 108
6	Thermal Shock	-65°C to +125°C, 100 cycles, DCR change within $\pm 20\%$, no mechanical damage	MIL-STD-202 Method 107
7	Mechanical Vibration	5-3000Hz, 0.4 inch double amplitude or 30G peak, DCR change within $\pm 20\%$, no mechanical damage	MIL-STD-202 Method 204
8	Mechanical Shock	1500 G, 0.5 milliseconds, half-sine shocks, DCR change within $\pm 20\%$, no mechanical damage	MIL-STD-202 Method 213
9	Salt Spray	5% salt solution, 48 hour exposure, DCR change within $\pm 20\%$, no excessive corrosion	MIL-STD-202 Method 101
10	Moisture Resistance	10 cycles, DCR change within $\pm 20\%$, no excessive corrosion.	MIL-STD-202 Method 106

Fuse Selection and Temperature De-rating Guideline:

The ambient temperature affects the current carrying capacity of fuses. When a fuse is operating at a temperature higher than 25°C, the fuse shall be “de-rated” according to the de-rating curve.

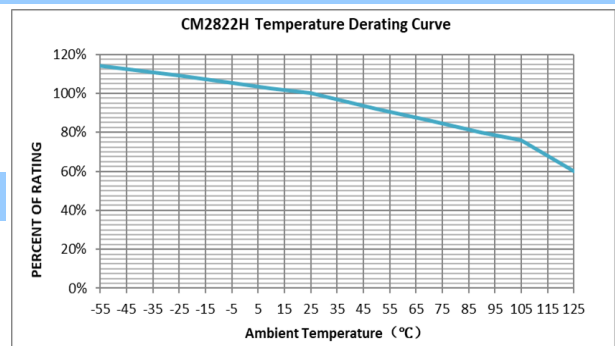

Packaging:

Chip Size	Parts on 13 inch (330 mm) Reel
2822	1,000 pcs

High Power Surface Mount Fuse

CM2822H Series

Recommended Temperature Profile for Reflow Soldering:

Profile Feature	Pb-Free Assembly
Preheat/Soak	
Temperature Min (T_{smin})	150°C
Temperature Max (T_{smax})	200°C
Time (t_s) from (T_{smin} to T_{smax})	60~120 seconds
Ramp-up rate (T_L to T_p)	3°C/second max.
Liquidous temperature (T_L)	217°C
Time(t_L) maintained above T_L	60~150 seconds
Peak package body temperature (T_p)	260°C
Time (t_p)*within 5°C of the specified classification temperature (T_c)	30 seconds *
Ramp-down rate (T_p to T_L)	6°C/second max.
Time 25°C to peak temperature	8 minutes max.
* Tolerance for peak profile temperature (T_p) is defined as a supplier minimum and a user maximum	

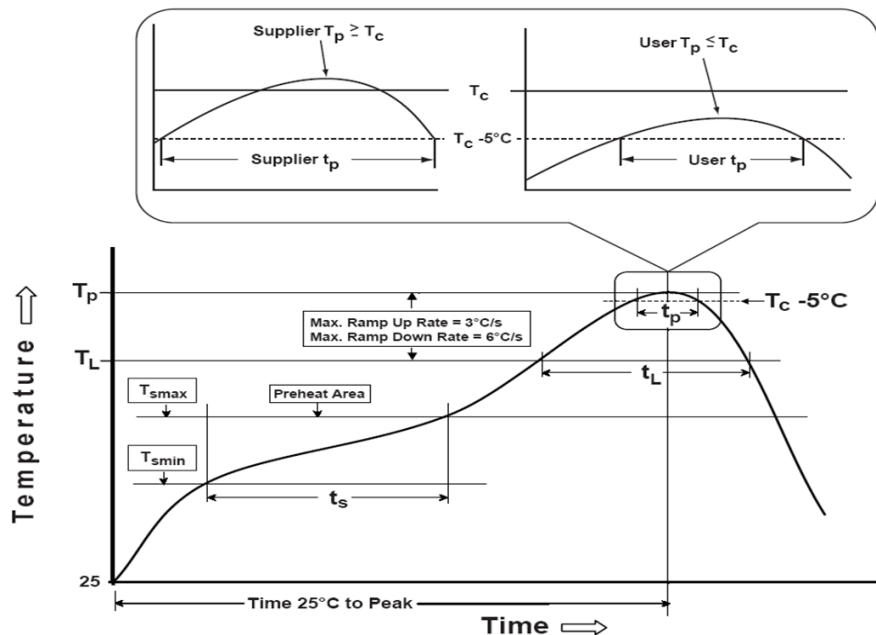

Recommended conditions for hand soldering:

1. Appropriate temperature (max.) of soldering iron tip/soldering time (max.): 280°C / 10 s or 350°C / 3 s
2. Using hot air rework station with tip that can melt the solder on both terminations at the same time is strongly recommended. Do not directly contact the chip termination with the tip of soldering iron.

Storage:

1. The maximum ambient temperature shall not exceed 35°C . Storage temperatures higher than 35°C could result in the deformation of packaging materials.
2. The maximum relative humidity recommended for storage is 75%. High humidity with high temperature can accelerate the oxidation of the solder plating on the termination and reduce the solderability of the components.
3. The products shall not be stored in areas where harmful gases containing sulfur or chlorine are present.
4. MSL=1

High Power Surface Mount Fuse

CM2822H Series



Features:

- High safety with ceramic body and special arc-extinguishing filler
- High interrupting current ratings for high power protection
- Single small case size for current rating from 20A to 125A
- High reliability for long time operation
- Automotive grade with AEC-Q200 qualification
- Halogen free, RoHS compliant and 100% lead-free

Clearing Time Characteristics:

% of Current Rating	Clearing Time at 25°C	
	Min.	Max.
100%	4 hours	
250%		60 seconds

Shape and Dimensions:

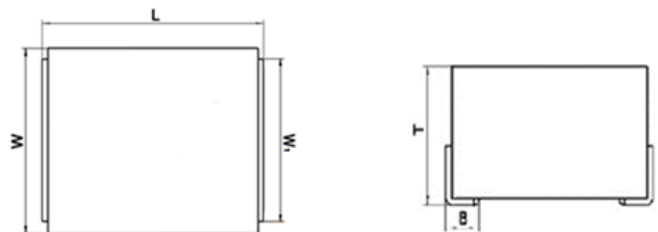

Unit	Inch	mm
L	0.287 ± 0.012	7.3 ± 0.3
W	0.228 ± 0.008	5.8 ± 0.2
W ₁	0.201 ± 0.008	5.1 ± 0.2
T	0.165 ± 0.008	4.2 ± 0.2
B	0.051 ± 0.012	1.3 ± 0.3

Applications:

- Server Systems
- Routers and switches
- Telecom DC/DC Power
- Drones
- Power tools
- Battery and BMS

Agency Approval:

Recognized Under the Components Program of Underwriters Laboratories. File Number: E507943.

Ordering Information:

Part Number	Current Rating (A)	Voltage Rating (Vdc)	Interrupting Rating	Nominal DCR (mΩ) ¹	Nominal I ² t (A ² s) ²	Marking ⁴
CM2822H20A0T	20	125	300A @ 125Vdc 1,000A @ 75Vdc ³ 1,500A @ 48Vdc ³	2.1	120	△CMH 20 R
CM2822H30A0T	30			1.35	270	△CMH 30 R
CM2822H40A0T	40			1.05	400	△CMH 40 R
CM2822H50A0T	50			0.85	600	△CMH 50 R
CM2822H60A0T	60	75	1,000A @ 75Vdc ³ 1,500A @ 48Vdc ³	0.74	900	△CMH 60 R
CM2822H70A0T	70			0.61	1,400	△CMH 70 R
CM2822H80A0T	80			0.53	2,000	△CMH 80 R
CM2822H90A0T	90			0.48	2,400	△CMH 90 R
CM2822H100AT	100			0.44	3,600	△CMH 100 R
CM2822H125AT	125			0.38	6,000	△CMH 125 R

1. Measured at ≤10% rated current and 25 °C ambient
2. Melting I_{2t} at 10X I_n
3. Time constant of interrupting test less than 0.1ms
4. Black marketing character code or laser marking code

High Power Surface Mount Fuse
CM2822H Series

Clearing Time vs. Current Curves:

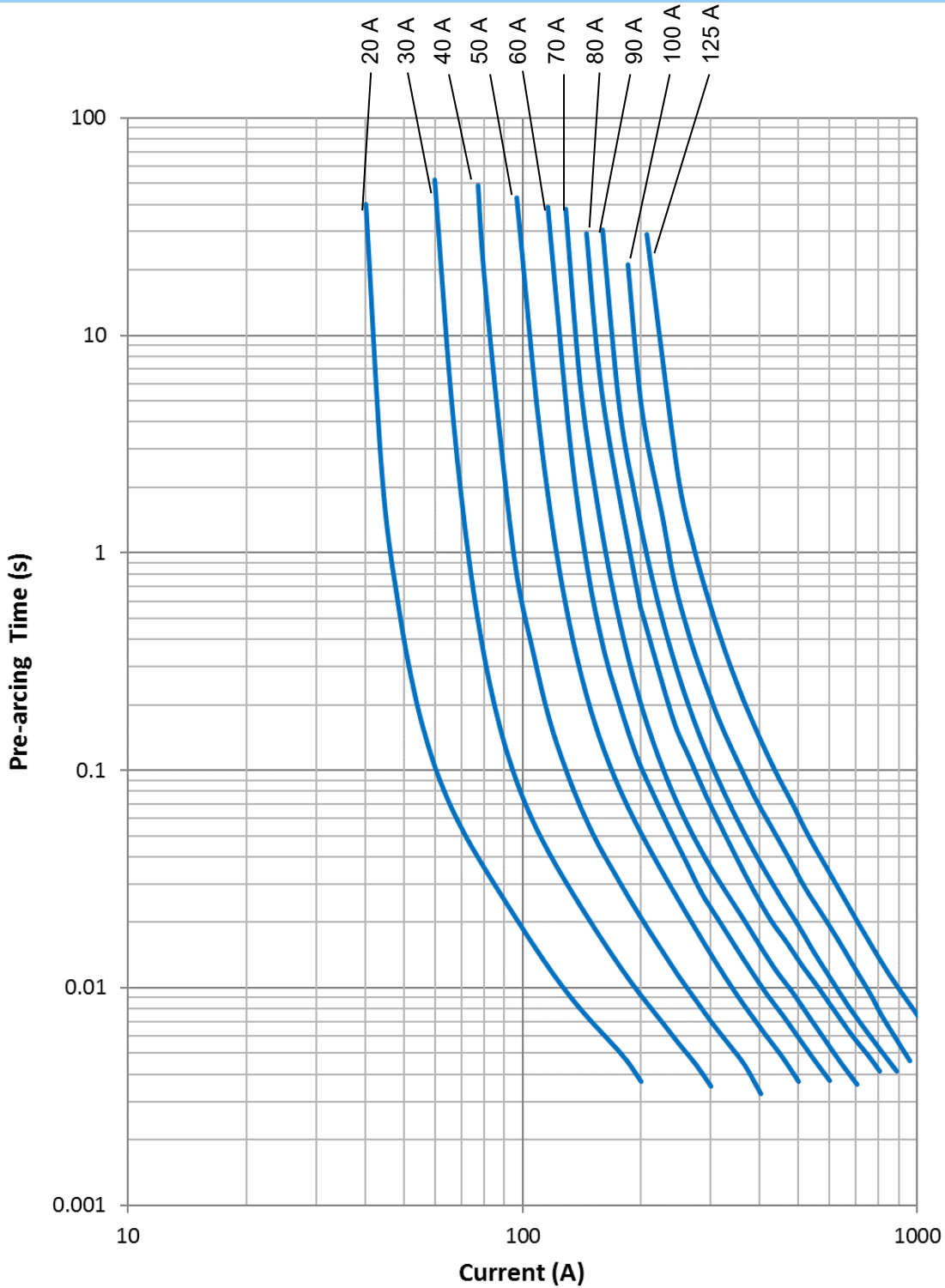

High Power Surface Mount Fuse

CM2822H Series

Average I^2t vs. t Curves:

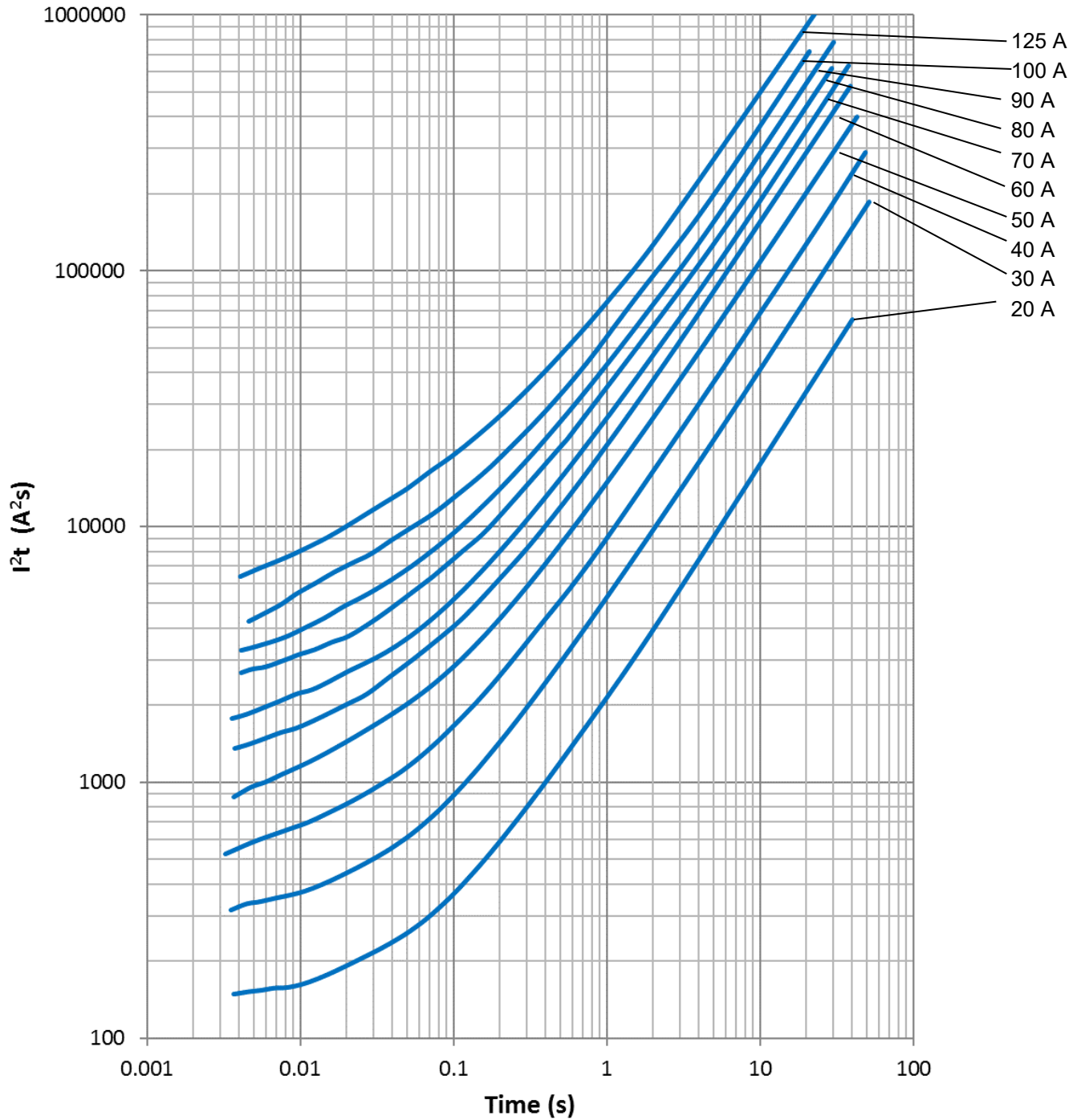

Disclaimer

Specifications are subject to change without notice. AEM products are designed for specific applications and should not be used for any purpose (including, without limitation, automotive, aerospace, medical, life-saving applications, or any other application which requires especially high reliability for the prevention of such defect as may directly cause damage to the third party's life, body or property) not expressly set forth in applicable AEM product documentation. It is the customer's responsibility to validate that a particular product with the properties described in the product specification is suitable for use in a particular application. Warranties granted by AEM shall be deemed void for products used for any purpose not expressly set forth in applicable AEM product documentation. AEM shall not be liable for any claims or damages arising out of products used in applications not expressly intended by AEM as set forth in applicable AEM product documentation. The sale and use of AEM products is subject to AEM terms and conditions of sale. Please refer to AEM's website for updated catalog and terms and conditions of sale.



AEM Components (Suzhou) Co., Ltd

**461 Zhongnan Street,
China-Singapore Suzhou Industrial Park
Jiangsu, P. R. China, 215026**

Tel: 86-512-6258-0028
Fax: 86-512-6258-0018
Email: marketing@aemchina.com

AEM Components (USA), Inc.

6670 Cobra Way, San Diego, CA 92121, USA

Tel: 1-858-750-6100
Fax: 1-858-481-1123
Email: sales@aemcomponents.com